

KAWAI

Digital Piano
CN4

Owner's Manual

Important Safety Instructions

SAVE THESE INSTRUCTIONS

INSTRUCTIONS PERTAINING TO A RISK OF FIRE, ELECTRIC SHOCK, OR INJURY TO PERSONS



WARNING
TO REDUCE THE RISK OF FIRE OR ELECTRIC SHOCK, DO NOT EXPOSE THIS PRODUCT TO RAIN OR MOISTURE.

AVIS : RISQUE DE CHOC ELECTRIQUE - NE PAS OUVRIR.

TO REDUCE THE RISK OF ELECTRIC SHOCK, DO NOT REMOVE COVER (OR BACK). NO USER-SERVICEABLE PARTS INSIDE. REFER SERVICING TO QUALIFIED SERVICE PERSONNEL.



The lightning flash with arrowhead symbol, within an equilateral triangle, is intended to alert the user to the presence of uninsulated "dangerous voltage" within the product's enclosure that may be of sufficient magnitude to constitute a risk of electric shock to persons.



The exclamation point within an equilateral triangle is intended to alert the user to the presence of important operating and maintenance (servicing) instructions in the literature accompanying the product.

Examples of Picture Symbols



denotes that care should be taken. The example instructs the user to take care not to allow fingers to be trapped.



denotes a prohibited operation. The example instructs that disassembly of the product is prohibited.



denotes an operation that should be carried out. The example instructs the user to remove the power cord plug from the AC outlet.

Read all the instructions before using the product.

WARNING - When using electric products, basic precautions should always be followed, including the following.



WARNING Indicates a potential hazard that could result in death or serious injury if the product is handled incorrectly.

The product should be connected to an AC outlet of the specified voltage.



- If you are going to use an AC power cord, make sure that its has the correct plug shape and conforms to the specified power voltage.
- Failure to do so may result in fire.

Do not insert or disconnect the power cord plug with wet hands.

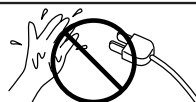

Doing so may cause electric shock.

The chair must be used properly(it must be used only when playing the product).

- Do not play with it or stand on it.
- Only one person is allowed to sit on it.
- Do not sit on it when opening the lid.
- Re-tighten the bolts occasionally.

Doing so may cause the chair to fall over or your fingers to be trapped, resulting in injury.

When using the headphones, do not listen for long periods of time at high volume levels.

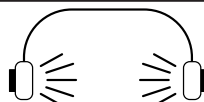

Doing so may result in hearing problems.

Do not lean against the keyboard.



Doing so may cause the product to fall over, resulting in injury.

Do not disassemble, repair or modify the product.



Doing so may result in product breakdown, electric shock or short-circuit.

When disconnecting the AC power cord's plug, always hold the plug and pull it to remove it.



● Pulling the AC power cord itself may damage the cord, causing a fire, electric shock or short-circuit.

The product is not completely disconnected from the power supply even when the power switch is turned off. If the product will not be used for a long time, unplug the AC power cord from the AC outlet.



● Failure to do so may cause fire in case of lightning.
● Failure to do so may over-heat the product, resulting in fire.

This product may be equipped with a polarized line plug (one blade wider than the other). This is a safety feature. If you are unable to insert the plug into the outlet, contact an electrician to replace your obsolete outlet. Do not defeat the safety purpose of the plug.

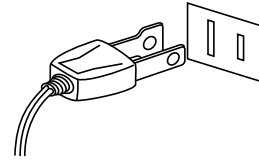

CAUTION

Indicates a potential hazard that could result in injury or damage to the product or other

Do not use the product in the following areas.

- Areas, such as those near windows, where the product is exposed to direct sunlight
- Extremely hot areas, such as near a heater
- Extremely cold areas, such as outside
- Extremely humid areas
- Areas where a large amount of sand or dust is present
- Areas where the product is exposed to excessive vibrations

Using the product in such areas may result in product breakdown. Use the product only in moderate climates (not in tropical climates).

When you close the keyboard cover, close it gently.



Closing it roughly may trap your fingers, resulting in injury.

Before connecting cords, make sure that the power to this product and other devices is turned OFF.



Failure to do so may cause breakdown of this product and other devices.

Take care not to allow any foreign matter to enter the product.



Entry of water, needles or hair pins may result in breakdown or short-circuit. The product shall not be exposed to dripping or splashing. No objects filled with liquids, such as vases, shall be placed on the product.

Do not drag the product on the floor. Take care not to drop the product.



Please lift up the product when moving it. Please note that the product is heavy and must be carried by more than two persons. Dropping the product may result in breakdown.

Do not place the product near electrical appliances such as TVs and radios.



● Doing so may cause the product to generate noise.
● If the product generates noise, move the product sufficiently away from the electrical appliance or connect it to another AC outlet.

When connecting the AC power cord and other cords, take care not to get them tangled.



Failure to do so may damage them, resulting in fire, electric shock or short-circuit.

Do not wipe the product with benzene or thinner.



● Doing so may result in discoloration or deformation of the product.
● When cleaning the product, put a soft cloth in lukewarm water, squeeze it well, then wipe the product.

Do not stand on the product or exert excessive force.



- Doing so may cause the product to become deformed or fall over, resulting in breakdown or injury.

The product should be located so that its location or position does not interfere with its proper ventilation. Ensure a minimum distance of 5cm around the product for sufficient ventilation. Ensure that the ventilation is not impeded by covering the ventilation openings with items, such as newspaper, table-cloths, curtains, etc.

Do not place naked flame sources, such as lighted candles on the product.

The product should be serviced by qualified service personnel when:

- The power supply cord or the plug has been damaged.
- Objects have fallen, or liquid has been spilled into the product.
- The product has been exposed to rain.
- The product does not appear to operate normally or exhibits a marked change in performance.
- The product has been dropped, or the enclosure damaged.

Notes on Repair

Should an abnormality occur in the product, immediately turn the power OFF, disconnect the power cord plug, and then contact the shop from which the product was purchased.

CAUTION:

To prevent electric shock, match wide blade of plug to wide slot, fully insert.

ATTENTION:

Pour éviter les chocs électriques, introduire la lame la plus large de la fiche dans la borne correspondante de la prise et pousser jusqu'au fond.

Instruction for AC power cord (U.K.)

Do not plug either terminal of the power cord to the ground of the AC outlet on the wall.

FCC Information

This equipment has been tested and found to comply with the limits for a Class B digital device, pursuant to Part 15 of the FCC Rules. These limits are designed to provide reasonable protection against harmful interference in a residential installation. This equipment generates, uses and can radiate radio frequency energy and, if not installed and used in accordance with the instructions, may cause harmful interference to radio communications.

If this equipment does cause harmful interference to radio or television reception, which can be determined by turning the equipment off and on, the user is encouraged to try to correct the interference by one or more of the following measures:

- Reorient or relocate the receiving antenna.
- Increase the separation between the equipment and receiver.
- Connect the equipment into an outlet on a different electrical circuit from the receiver.
- Consult the dealer or an experienced radio/TV technician for help.

Canadian Radio Interference Regulations

This instrument complies with the limits for a class B digital apparatus, pursuant to the Radio Interference Regulations, C.R.C., c. 1374.

THANK YOU FOR PURCHASING A KAWAI DIGITAL PIANO!

The Kawai digital piano is a revolutionary new keyboard instrument that combines the latest in electronic advances with traditional craftsmanship inherited from Kawai's many years of experience in building fine pianos. Its keyboard provides the touch response and full dynamic range required for a superb performance on the piano, harpsichord, organ, and other instruments. In addition, the CN piano is equipped with reverb and a digital effect processor for an even fuller sound. Industry-Standard MIDI (Musical Instrument Digital Interface) jacks are included which allow you to play other electronic instruments at the same time—opening a whole new world of musical possibilities.

This Owner's Manual contains valuable information that will help you make full use of this instrument's many capabilities. Please read all sections carefully and keep this manual handy for further reference.

READ ME FIRST

Before beginning the assembly of your CN4 read and become familiar with the assembly instructions that follow. Then, carefully unpack the piano and check your unit against the parts list.

PARTS PROVIDED

Side Panel (A)	2 pcs.
Back Board (B)	1 pc.
Pedal Board (C)	1 pc.
Screw (D) (M6 x 25)	4 pcs.
Screw (E) (ø4 x 16)	6 pcs.
Screw (F) (ø4 x 25)	2 pcs.
Adjuster (G)	1 pc.
Cord Clamp (H)	1 pc.
Headphone Hook	1 pc.

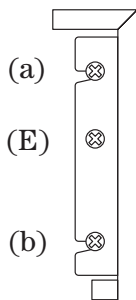
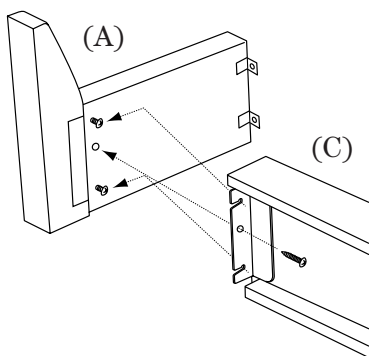
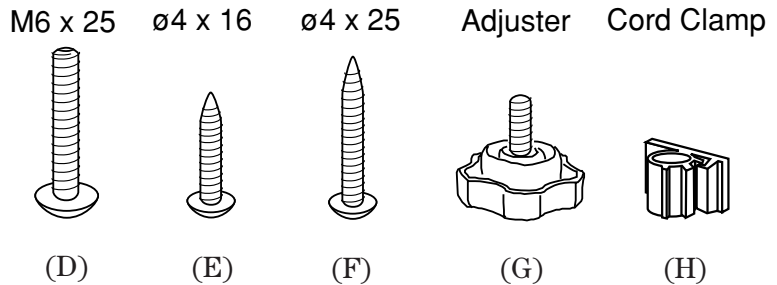

1. Insert the Adjuster (G) on the Pedal Unit.
2. Untie the pedal cable on the bottom of the Pedal Board (C).
3. Slide the metal bracket located at the end of Pedal Board (C) on to screws (a) and (b) of Side Panel (A). Install tighten screw (E) then tighten screws (a) and (b). Repeat this procedure on the other end of the Pedal Board, then raise the completed stand assembly.

4. Fasten Side Panel (A) and Back Panel (B) with two screws (F). Then fix Back Panel (B) to Pedal Board (C) with four screws (E).

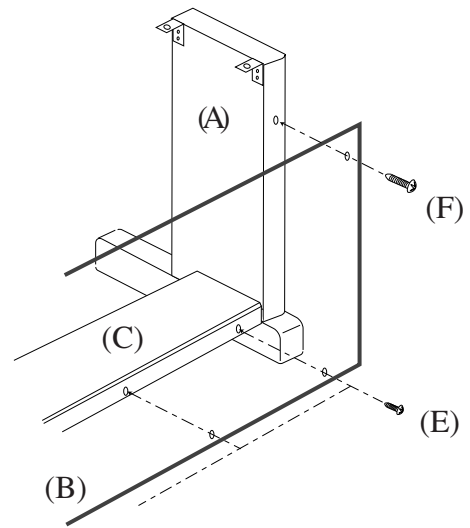

CAUTION:

To prevent personal injury, do not handle the main unit from the ends.

5. The next step requires one person on each end of the main unit. Grasp the unit with both hands, one under the front, the other under the rear (remember, not the end) and carefully center the main unit on top of the stand so that the hook brackets located on the bottom rear of the main unit are inside the stand side panels (A) and approximately one-third of the rear, top edge of the side panels are exposed. (See the illustration to the right)

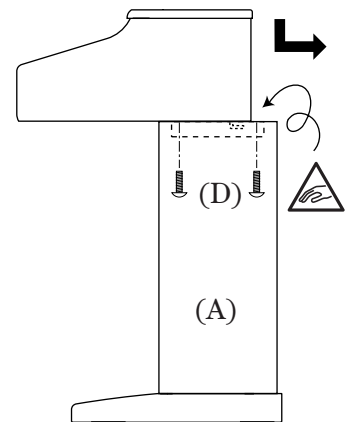

6. Maintaining a firm grasp under the front of the main unit slide it toward the rear of the stand until the hook brackets engage the brackets at the rear top of the side panels (A). This hook arrangement is design to prevent the main unit from tilting forward while the screws are installed. Keep one hand under the front of the main unit, push down on the front to be certain that hooks are properly engaged.

7. Fasten the main unit and the stand with four screws (D).

CAUTION:

Be sure to secure the main unit to the stand with the screws. If you fail to do so, the unit could fall from the stand causing damage or personal injury.

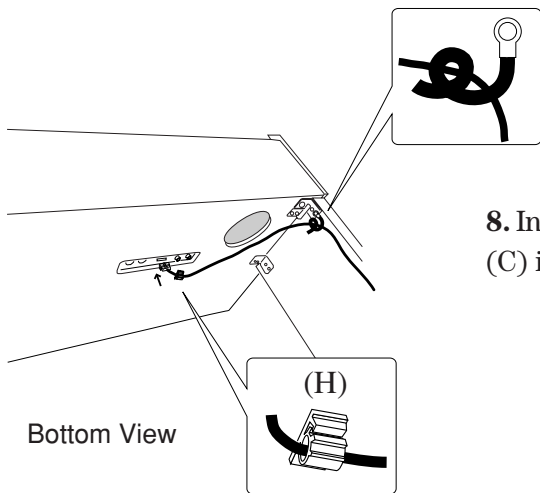

8. Insert the pedal connection cord that comes from Pedal Board (C) into the piano's pedal jack and fasten with cord clamps.

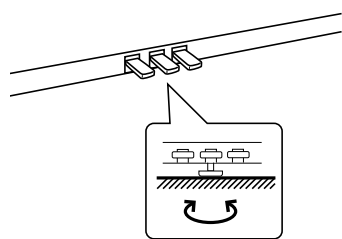

9. Turn the adjuster (installed on the bottom of the Pedal Unit) down until it makes firm contact with the floor. If the floor is carpeted, place a spiked furniture cup under the adjuster so that it makes firm contact with the carpet backing. Press any pedal with your foot. If the pedal rail flexes, lower the adjuster until flexing is minimized.

CAUTION:

Before moving your piano, turn the adjuster up so that it clears the floor.

ATTACHING THE HEADPHONE HOOK (OPTION)

1. Fix the headphone hook to the bottom of the piano with two screws packed in the same plastic bag.

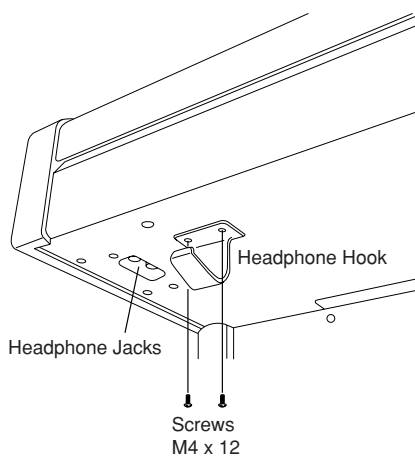

1. Quick Start **p. 6**

1.1 <i>SETTING UP THE PIANO</i>	6
1.2 <i>POWER SWITCH</i>	6
1.3 <i>VOLUME SLIDER</i>	6
1.4 <i>HEADPHONES</i>	6
1.5 <i>DEMO SONGS</i>	6
1.6 <i>PLAYING THE PIANO</i>	7
1.7 <i>PEDALS</i>	8
1.8 <i>PLAYING WITH MORE SOUNDS</i>	8

2. Advanced Playing **p. 9**

2.1 <i>VALUE BUTTONS</i>	9
2.2 <i>DUAL</i>	9
2.3 <i>SPLIT</i>	9
2.4 <i>DUAL/SPLIT BALANCE SLIDER</i>	10
2.5 <i>EFFECTS/REVERB</i>	10
2.6 <i>METRONOME/RHYTHM</i>	12

3. Lesson Function **p. 14**

3.1 <i>SELECTING A BOOK/SONG</i>	14
3.2 <i>PLAYING BACK A SONG</i>	14
3.3 <i>RECORDING YOUR PRACTICE</i>	15

4. Playing with the Concert Magic **p. 16**

4.1 <i>SELECTING A SONG</i>	16
4.2 <i>LISTENING TO THE SONG</i>	16
4.3 <i>PERFORMING A SONG</i>	17
4.4 <i>PART VOLUME BALANCE FOR CONCERT MAGIC</i>	18
4.5 <i>CONCERT MAGIC SONG ARRANGEMENT TYPES</i>	18
4.6 <i>STEADY BEAT</i>	20
4.7 <i>CONCERT MAGIC SONG DEMO</i>	20
4.8 <i>ADJUSTING THE PLAYBACK SPEED FOR THE CONCERT MAGIC SONGS</i>	21

5. Recorder **p. 22**

<i>BASICS OF THE RECORDER</i>	22
5.1 <i>RECORDING (REC BUTTON)</i>	23
5.2 <i>PLAYING BACK A SONG (PLAY/STOP BUTTON)</i>	25
5.3 <i>ERASING A SONG</i>	26

6. Disk Operations p. 28

6.1 <i>DISK RECORDER</i>	28
6.2 <i>DISK MENU</i>	31

7. Touch, Transpose and Menu Functions p. 34

7.1 <i>TOUCH</i>	34
7.2 <i>TRANPOSE</i>	34
7.3 <i>MENU BUTONS</i>	35
<i>BRILLIANCE</i>	36
<i>LOWER OCTAVE SHIFT</i>	36
<i>LOWER PEDAL ON/OFF</i>	37
<i>LAYER OCTAVE SHIFT</i>	37
<i>LAYER DYNAMICS</i>	37
<i>DAMPER HOLD</i>	38
<i>TUNING</i>	38
<i>TEMPERAMENT</i>	38
<i>KEY OF TEMPERAMENT</i>	40
<i>MIDI CHANNEL</i>	41
<i>LOCAL CONTROL ON/OFF</i>	41
<i>TRANSMIT PROGRAM CHANGE ON/OFF</i>	41
<i>SENDING PROGRAM CHANGE NUMBERS</i>	42
<i>MULTI-TIMBRAL MODE</i>	42
<i>CHANNEL MUTE</i>	42
<i>MIDI CLCOK</i>	43
<i>USER MEMORY</i>	43
<i>FACTORY RESET</i>	44

8. Using MIDI p. 45

<i>MIDI EXAMPLES</i>	45
----------------------------	----

9. Jacks p. 46

<i>MIDI JACKS</i>	46
<i>USB JACK</i>	46
<i>LINE OUT JACKS</i>	46
<i>LINE IN JACKS</i>	46
<i>HEADPHONE JACKS</i>	46
<i>NOTES ABOUT USB</i>	47

10. Appendices p. 48

1. QUICK START

1.1 SETTING UP THE PIANO

The first thing you'll need to do before playing the piano is to set up the instrument.

ASSEMBLING THE STAND

First, you need to assemble the stand unit. Assemble the stand following the instructions at the beginning of this manual.

SUPPLYING AC POWER

The CN piano is equipped with stereo speakers and an amplifier. You do not need any other equipment to play your piano. You can enjoy the CN piano wherever AC power is available. Simply connect the power cable that comes with the CN piano to an AC outlet.

Connect the AC power cable to the piano's power jack and the other end of the cable to the AC outlet on the wall.

1.2 POWER SWITCH



**Press this button to turn on the power.
Pressing it again will turn off the power.**

Pressing this button while holding down the REC and PLAY/STOP buttons will erase all the songs currently stored in the Recorder. (See page 27.)

1.3 VOLUME SLIDER

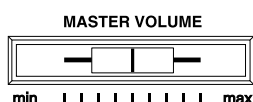

This slider controls the master volume level of the piano's sound.

Move this slider to the right to increase the volume and move to the left to decrease the volume.

This slider also controls the headphone's volume and the LINE output level of the piano's sound.

1.4 HEADPHONES

For private performances you may want to use the headphones. The speakers will be turned off automatically when the headphones are plugged in, and the CN piano will only be heard through the headphones. The CN piano has two headphones jacks.

1.5 DEMO SONGS

The CN4 has 30 built-in sound demo songs. Each of the demo songs presents a musical piece to introduce the different preset sounds.

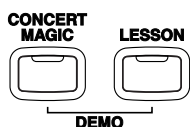

Press the **CONCERT MAGIC** and **LESSON** buttons simultaneously and the demo song for the Piano 1 category will start. After the Piano 1 demo songs are finished playing, the demo songs for another sound category will be selected at random.

If you would like to listen to the demos for a particular category, just press the desired **SOUND SELECT** button while the demo is playing. When you press the button, the demo will play the demo songs for the newly selected category. Then the demo songs for another category will be selected at random. See page 64 for the list of sound demo songs.

1.6 PLAYING THE PIANO



Turning on the power.

You will find the **POWER SWITCH** at the left end of the front panel. Press this button to turn on the power. Pressing it again will turn off the power.

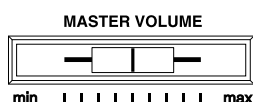

Adjust the volume level.

The **VOLUME SLIDER** controls the volume level of the speakers and the headphones. Use this slider to set the volume to a comfortable listening level.

Now try playing the keyboard.

You will hear the CN's main piano sound. The name of the sound "Concert Grand" is shown in the LCD Display.

Concert Grand

The CN piano responds just like a real acoustic piano when you play it. It produces a louder sound when you play hard and a softer sound when you play soft. The volume level changes in relation to how fast the keys are pressed. This system is called "**touch sensitivity**" on an electronic musical instrument. The initial touch sensitivity setting has been adjusted to the standard of an acoustic piano. You can however, select a different type of touch sensitivity on the CN piano if you are not comfortable with the standard setting. For more detail, please read "**7.1 Touch**" on page 34.

1.7 PEDALS

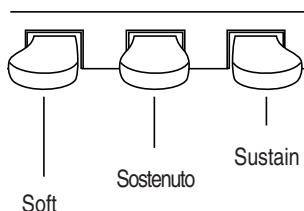

The CN piano has three pedals—just like a grand piano. They are Sustain, Soft and Sostenuto.

1.8 PLAYING WITH MORE SOUNDS

You have already heard the CN's main piano sound. The CN4 has a total of 305 sounds + 9 drum sets, not only different types of piano sounds but different instruments as well.

The different instrument sounds built into CN piano are called “**preset sounds**”.

All of the preset sounds have been created through advanced digital sampling technology achieving as natural and realistic sound as possible. Let's try some of the preset sounds.

SELECTING ANOTHER PRESET SOUND

Press the **SOUND SELECT** button under the name of the instrument you would like to listen to. When the button is pressed, the LED indicator will be turned on to indicate that this sound is selected.

The name of the selected preset sound is also shown in the LCD Display.



The SOUND SELECT buttons are assigned with four preset sounds to select. **To select the other sounds, press the button repeatedly.**

You can also select any preset sounds by using the VALUE buttons.

◆ NOTE

The OTHERS button is assigned with 278 sounds (including 9 drum sets). While holding down one of the VALUE buttons, pressing the other VALUE button will jump to the next sound category within the OTHERS button.

2. ADVANCED PLAYING

2.1 VALUE BUTTONS

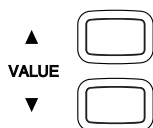

These two buttons are used to change the value for certain functions.

First select the function or option you would like to change the value for by pressing the appropriate button(s), then use the VALUE buttons to change the value. “▲” button increases the value and “▼” decreases the value.

These buttons can also be used to select the various sounds. You can select all of the preset sounds assigned to the ten SOUND SELECT buttons.

However, sounds cannot be selected by using the Value buttons when you are in DUAL or SPLIT mode.

2.2 DUAL

Another feature of the CN piano is the ability to layer two preset sounds together to create a more complex sound. For example, piano layered with strings, electric piano with choir sound, and so on.

To layer two sounds, press the SOUND SELECT buttons for both sounds simultaneously. The LED indicators for each will be turned on to indicate the two sounds you have chosen. You will find the selected sound names are also shown in the LCD display.

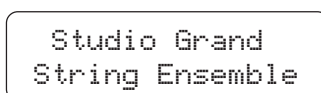

Both sound names are displayed.

If you want to layer two sounds assigned to the same SOUND SELECT button, while pressing the desired SOUND SELECT button use the VALUE buttons to select your desired layered sound.

ABOUT POLYPHONY

The CN piano is capable of playing up to 96 notes simultaneously (96-note polyphony). When playing in dual mode, or when playing the stereo piano sound, the polyphony will be reduced by half since the piano has to produce two sounds for each note.

2.3 SPLIT

SELECTING SPLIT SOUNDS

The split function divides the keyboard into two sections—upper and lower—and lets you play each part with a different sound.



First press the desired **SOUND SELECT** button to select the upper sound. Then, while holding down the **SPLIT** button, press the desired **SOUND SELECT** button to select the lower sound. The LED Indicator for the upper sound will be turned on and the LED for the lower sound will start flashing.

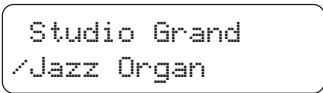

The LCD Display shows you which sounds are selected for the upper and lower sections.

CHANGING THE SPLIT POINT

The default split point is set between B2 and C3. This point can be moved to anywhere on the keyboard.

Press the desired key while holding down the SPLIT button.

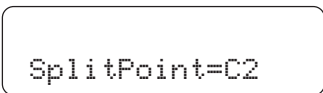

The LCD Display shows you which key you pressed

The key you pressed becomes the lowermost note for the upper section.

2.4 BALANCE SLIDER



You can adjust the volume balance between the two sounds in Dual or Split mode. **Use the BALANCE slider to adjust the balance.** Move the slider to the right to increase the volume of the sound shown on the top line of the display and decrease the volume of the sound shown on the bottom line of the display. The balance changes in the opposite way when the slider is moved to the left.

2.5 EFFECTS/REVERB

You might have noticed that when you select some of the preset sounds, the LED indicator for the **EFFECTS** or the **REVERB** is turned on. The reason for this is some of the preset sounds are set up with an effect on as their initial setting.

Adding an effect to the sound enhances tonal quality and improves acoustical realism. The CN piano is provided with two separate groups of effects. The first is reverb and the second contains chorus, flanger, delay, tremolo and rotary speaker.

REVERB

Reverb adds reverberation to the sound, simulating the acoustic environment of a recital room, stage, or concert hall. There are six types of reverb available. They are Room 1&2, Stage, Hall 1&2 and Plate.

CHORUS

Chorus is an effect that simulates the rich character of a vocal choir or string ensemble, by layering a slightly detuned version of the sound over the original to enrich it. There are five types of chorus available. They are Chorus 1-4 and Feedback Chorus.

FLANGER

Flanger creates a shifting comb-filter, which adds motion and a “hollow” tone to the sound.

DELAY

Delay is an effect that adds echoes to the sound. There are three types of delay available (delay 1 - 3), each of which has a different length of delay between the echoes.

TREMOLO

Tremolo modulates the volume of the sound. This is a vibrato type effect.

ROTARY

This effect simulates the sound of the Rotary Speaker cabinet commonly used with electronic organs. Rotary 1 is normal rotary and Rotary 2 is with distortion effect.

The soft pedal is used to change the speed of the rotor between SLOW and FAST.

TO ADD REVERB



Press the REVERB button. The LED indicator will be turned on to indicate that reverb is in use. Press and hold the REVERB button and the currently selected reverb type will be shown in the LCD display.

```
Reverb Type
= Room 1
```

The LCD Display shows the currently selected reverb.

To change the reverb type, use the VALUE buttons.



TO ADD OTHER EFFECTS

Press the EFFECTS button. The LED indicator will be turned on to indicate that the effect is in use. Press and hold the EFFECTS button and the currently selected effect will be shown in the LCD display.

```
Effect Type
= Chorus 1
```

The LCD Display shows the currently selected effect.

To change the effect type, use the VALUE buttons.

To turn off the reverb or effects, press the REVERB or EFFECTS button again.

◆ NOTE

Any changes you make to the reverb and the effects are stored with the preset sound in memory as long as the power is on. When you reselect a sound, your chosen reverb and effect settings will be recalled along with the preset sound. When the power is turned off the effects will be reset to the factory settings unless you use the “User Memory” function to save your current reverb and effect settings. For more information about the “User Memory” function please see page 43 in this manual.

2.6 METRONOME/RHYTHM

Rhythm is one of the most important elements when learning music. It is important to practice playing the piano at the correct tempo and with a steady rhythm. The CN piano’s metronome is a tool that helps you to achieve this by providing a steady beat for you play along with.

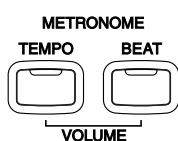

STARTING THE METRONOME

Press the TEMPO button. You will see the LED indicator turn on and hear the metronome begin counting with a steady beat. The LCD display shows the tempo in beats per minute.

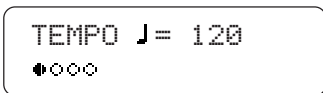

TEMPO J= 120
◆○○○

Tempo is displayed in number of beats per minute.

To change the tempo, use the VALUE buttons to increase or decrease the tempo within the range of 10 - 400 beats per minute. (20-800 BPM with eighth note rhythms).

To stop the metronome, press the TEMPO button again.

CHANGING THE TIME SIGNATURE

You probably noticed that there are two types of clicks and the louder one comes every fourth beat. The metronome is capable of giving you a down beat to indicate the beginning of the measure. You are now hearing a 4-beat or 4/4 time signature.

You can select a different time signature, if you want to. There are ten different time signatures available on the CN piano—1/4, 2/4, 3/4, 4/4, 5/4, 3/8, 6/8, 7/8, 9/8 and 12/8. You can also select one of the 100 built-in rhythm styles instead of a simple metronome click.

To change the time signature, use the BEAT button.

Press the BEAT button. You will see the LED indicator turn on and hear the metronome begin counting. The LCD display shows the time signature and a visual indicator of beats per measure.



The selected time signature is displayed along with a visual indicator of beats per measure.

Use the VALUE buttons to select your desired time signature. You will see the time signature currently selected in the LCD display. The visual indicator will change to match the selected time signature.

RHYTHM METRONOME

You can also select from 100 additional rhythm styles instead of a simple metronome click.

Keep pressing the VALUE buttons to select the desired rhythm style number. See page 58 for the rhythm style list.

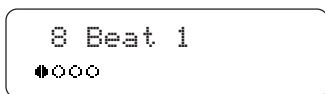

The selected Rhythm Style is displayed.

To stop the metronome, press the BEAT button again.

You can use either the TEMPO or BEAT button to turn the metronome on and off. Choose the appropriate button depending on whether you're adjusting the tempo or changing the time signature.

ADJUSTING THE METRONOME VOLUME

The volume level of metronome can be adjusted to any level you like independent of the main volume.

Press the TEMPO and BEAT buttons simultaneously. The LCD displays the volume level of the metronome in numbers from 1 (soft) to 10 (loud). The factory preset is 5.

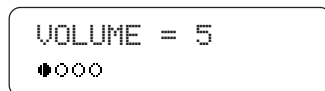

The volume level is displayed.

Use the VALUE buttons to change value.

◆ NOTE

All the metronome settings will be reset to the factory preset values after turning off the power unless you use the "User Memory" function to save your current metronome settings. For more information about the "User Memory" function please see page 43 in this manual.

3. LESSON FUNCTION

Lesson function helps you to practice the piano with popular piano methods. You can listen to an example, practice with right hand and left hand separately in various tempo, and even record your practice to play back and check up.

3.1 SELECTING A BOOK/SONG

Three popular piano methods, Burgmüller 25, Czerny 30, Czerny 100 and Beyer are installed in the CN4.

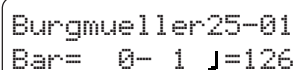

Press LESSON button. The LED indicator will be turned on and the LCD display will show the currently selected book and song number. **To change the book, use the MENU buttons.**

The image shows a rectangular LCD display with a pixelated font. The text on the display is "Burgmueller25-01" on the first line and "Bar= 0- 1 J=126" on the second line.

To change the song, use the VALUE buttons. You can also select a song directly by pressing a key on the keyboard while holding down the LESSON button. See page 59-61 for the song list.

3.2 PLAYING BACK A SONG



Press the PLAY/STOP button to play your selected song. There will be a one bar count-in before the song begins playing. To adjust the volume of the count-in, press and hold the TEMPO and BEAT buttons simultaneously and use the VALUE buttons to adjust the volume. You can adjust the volume balance of right hand part and left hand part with the balance slider. For instance, placing the slider all the way to the left will remove the pre-recorded right-hand part, allowing you to practice your right hand with the pre-recorded left-hand part. You can also adjust the speed or tempo of the song by using the VALUE buttons while holding down the TEMPO button. The tempo is shown in the LCD display **Press the PLAY/STOP button again to stop the song.**

Pressing the REW button rewinds the song and pressing the FF button forwards the song. The bar number and beat number are shown in the display. Press the RESET button to go back to the beginning of the song.

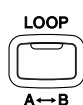

A-B LOOP

You can play back a specific part of a song repeatedly. **While playing back a song, press the LOOP button at the point you want to begin the playback from (point A) and press the LOOP button again at the point you want the playback to end (point B).** The recorder will play back the song between point A and B repeatedly until you press the

LOOP button again or the PLAY/STOP button to stop.

3.3 RECORDING YOUR PRACTICE

While in the Lesson function, you can record yourself for playback and evaluation. You will hear the pre-recorded left and right-hand parts as you record. You may use the BALANCE slider to mute either pre-recorded part.



Press the REC button (while the LESSON button is lit). The REC LED indicator will start flashing telling you that the piano is ready to record. The LCD display will show the bar and tempo information.

```
Record
Bar= 0- 1 ♩=126
```



Press the PLAY/STOP button and the recorder will give you one bar count-in then start recording. The LCD display will change to indicate that the recorder is now recording.

```
Recording
Bar= 4- 2 ♩=126
```

You may wish to turn on the Metronome while recording.

Press the PLAY/STOP button again to stop the recording and automatically reset to the beginning. To listen to your recording, press the PLAY/STOP button. You may re-record at any time.

◆ **NOTE**

The Lesson Recorder is a temporary recorder separated from the regular recorder. When you change the song, your recording will be erased. If you want to erase your recording without changing the song, press the PLAY/STOP button and REC button simultaneously. Recording again on the same song will also erase the previous recording.

◆ **NOTE**

When in Lesson mode, you can not select Dual or Split sounds.



4. PLAYING WITH CONCERT MAGIC

The great German composer Johann Sebastian Bach once said, “Playing the keyboard is simple. Just strike the right keys at the right time.”

Many people wish it were that simple. The reality is very different of course. However, there is a way to make playing the keyboard very simple. You don’t even have to strike the right keys thanks to Concert Magic.

With CONCERT MAGIC, absolutely anyone can sit at the CN piano and make real music... even if you’ve never taken a piano lesson in your life. To enjoy performing by yourself, you have only to select your favorite piece from 88 preprogrammed songs and tap any of the 88 piano keys with a steady rhythm and tempo. CONCERT MAGIC will provide the correct melody and accompaniment notes, regardless of which keys you press. Anybody, young or old, can enjoy CONCERT MAGIC from the moment they sit down at the CN piano.

Now let’s see how CONCERT MAGIC works.

4.1 SELECTING A SONG

The 88 Concert Magic songs are assigned to each of the 88 piano keys.

The songs are also classified in eight groups by song category such as Children’s Songs, American Classics, Christmas Songs.

All of the song titles are listed on page 65 in the appendices section of this manual.



To select a song, press the key to which your desired song is assigned while holding down the CONCERT MAGIC button.



1
Twinkle Twinkle

The LCD display shows you the song number and abbreviated song title.

4.2 LISTENING TO THE SONG

If you have selected a song you are familiar with, you may want to play by yourself right away. However you may want to listen to the song first before playing it.



To listen, press the PLAY/STOP button. The CN piano will start playing back the selected song. You can adjust the speed or tempo of the song by using the VALUE buttons while holding down the TEMPO button. While you are listening you can select a different Concert Magic song by using the VALUE buttons.

You probably noticed that the circles in the LCD display turn into smaller plus signs as the song is played back. This is called the Note Navigator.

These circles and plus signs provide a visual guide that shows you when to press the next key. The space between the circles and position of the circles in the LCD shows you the approximate timing between each key press.

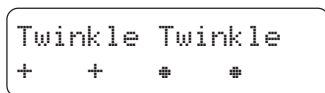

The circles turn into small plus signs as the song is playing.

The key to performing using Concert Magic is to know the rhythm of the song. The Note Navigator provides a rough outline of the songs rhythm, that will help you to learn the song's rhythm and then perform it by yourself.

If you want to listen to a different song, press the key to which your desired song is assigned while holding down the CONCERT MAGIC button. To listen, press the PLAY/STOP button.

When you are finished listening to the song, **press the PLAY/STOP button again to stop.**

4.3 PERFORMING A SONG

Now you're ready to play yourself.

Tap out the rhythm of the selected song on any one of the 88 black or white keys on the piano's keyboard.

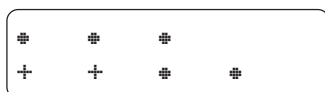

Use the Note Navigator (the circles and plus signs) to learn the rhythm of the Concert Magic song.

As you tap harder, the notes will get louder; as you tap softer, the notes will get quieter. As you tap faster, the notes speed up; as you tap slower, they will slow down correspondingly, just like regular piano playing.

Isn't it fun? You can sound like you've been playing for years just by pressing one key with one finger.

Concert Magic is a perfect method for small children to learn music, especially to develop a sense of rhythm. For older people who may think it is too late to learn the keyboard, Concert Magic is a good first step for them to begin with. With Concert Magic, your CN piano can be enjoyed by anyone in the family, even those who have never touched a musical instrument in their life.

Key on x x x x x x x x x x x x x x



When performing fast songs with Concert Magic, it is sometimes easier to tap two different keys with two fingers alternating. This allows you to play twice as fast as you can using only one finger on one key.

SKILLFUL

These songs range in difficulty from moderately difficult to difficult. To perform them, tap out the rhythm of both the melody and the accompaniment notes on any key on the keyboard, like “Waltz of the Flowers” shown below. The Note Navigator will be very helpful with the Skillful songs.



Key on x x x x x x x x x x x x x



It may take some practice to get them just right. A good way to learn these songs is to listen to them first, and then try to tap out the rhythms that you hear.

◆ **NOTE**

In the song list on page 65, the arrangement type is marked next to each song title as “**EB**” for Easy Beat, “**MP**” for Melody Play and “**SK**” for Skillful.

4.6 STEADY BEAT

Regardless of which arrangement type a Concert Magic song is, with Steady Beat you can play any Concert Magic song by simply tapping any key with a constant steady beat.



Press and hold the CONCERT MAGIC button. The LCD display will change to show the current Concert Magic mode in the second line.

Twinkle Twinkle
NORMAL

The current mode is NORMAL.

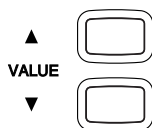

While still holding the CONCERT MAGIC button, **use the VALUE button to change the Concert Magic mode to STEADY BEAT.**

Twinkle Twinkle
STEADY BEAT

The mode is changed to STEADY BEAT.

Start by tapping any key with a constant steady beat. Your tapping will set the tempo for the song. Both the accompaniment and melody parts will be played automatically in time with the tempo you tap.

4.7 CONCERT MAGIC SONG DEMO

There are three ways to listen to the Concert Magic songs in the DEMO mode.

ALL PLAY

Press the CONCERT MAGIC button and then press the PLAY/STOP button without selecting a song. The CN piano will play back all of the Concert Magic songs in order.

RANDOM PLAY

Press the CONCERT MAGIC button and then press the LESSON button. The CN piano will play back all of the Concert Magic songs in random order.

CATEGORY PLAY

Press the piano key to which the desired song is assigned while holding down the CONCERT MAGIC and LESSON buttons. The CN piano will play back the selected song and, then play the rest of the songs in the same song category one after another.

To stop the demo, **press the PLAY/STOP button.**

4.8 ADJUSTING THE **PLAYBACK SPEED** FOR THE **CONCERT MAGIC SONGS**

The TEMPO button is also used to adjust the playback speed for the Concert Magic songs.

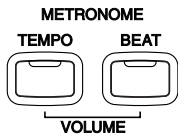

After selecting a Concert Magic song to play back, hold down the TEMPO button. The LCD display will show the tempo value. While holding down the TEMPO button, use the VALUE buttons to change the tempo.

You can adjust the tempo, either before playing back a song or while the song is playing back.

5. RECORDER

The CN piano's recorder records your playing much like a tape recorder, and it is just as easy to use. The CN piano records a song as digital data instead of audio data and stores the song inside the instrument. Because the song is stored as digital information you can modify the song when you play it back. You can, for example, adjust the tempo without changing the pitch or use a different effect setting from one you have recorded. Once you understand the recorder, you will find it to be a useful tool for both practicing and playing the piano.

BASICS OF THE RECORDER

Let's take a brief look at the recorder's features.

TWO-TRACK THREE-SONG RECORDER

The CN piano's recorder is a **2-track 3-song recorder**. This means you can record up to three different songs, store them in memory, and play them back as you like.

Each song has two separate tracks called "**Parts**" that can be recorded separately. This lets you record for example, the left hand part first on one track, then record the right hand part next on the other track while listening to the first track.

When you record or play back a song, you can select which part (track) of which song you are going to record or play back. When you are recording, selecting the same part again to record will erase any previous recordings on that part. Because of this it's important to remember; when recording both parts separately, after recording the first part be sure to select the second part to record, otherwise you will end up recording over the first part of the song.

RECORDED INFORMATION

The CN piano records the following:

Note information

Sound selection

Pedal movements

Balance settings Set the dual/split balance as desired before you start recording. The balance setting and the balance changes made during the recording will be recorded.

Transpose When you record in a different key using the transpose function, the CN piano will record the actual transposed notes you hear, not the notes as you play with the keyboard.

RECORDING CAPACITY

The total recording capacity is about 30,000 notes per song, 90,000 notes total. Pressing any buttons or pedals is counted as one note.

When the recorder reaches its maximum capacity, the CN piano will stop recording at that point.

RECORDER AND METRONOME

When playing back a song with the metronome turned on, the metronome always restarts with the down beat.

5.1 RECORDING (REC BUTTON)

The REC button is used for recording.

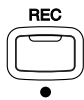

Press the REC button when you are ready to record. The LED indicator will start flashing telling you that the piano is ready to record.

```
Song1 Part=1
Record J=120
```

The LCD Display shows the Song and Part number, Bar and Tempo information.

Now play some music on the piano. The recorder will automatically start recording with the first note you play.



Press the PLAY/STOP button when you are finished recording. The piano will stop recording and save your song to memory.

Saving to memory may take a few moments and during this time the piano will not perform any other operations.

You can start recording by pressing the PLAY/STOP button instead of pressing a key. In this way, you can insert a blank bar at the beginning of the song.

If you make a mistake, you can record your piece again. Just repeat the same procedure. The second recording will completely erase the first one.

RECORDING ANOTHER SONG

The CN piano is capable of recording and storing up to three different songs. Let's try recording a second song.

If you followed the procedure in the previous section you have already recorded Song 1, so now let's record Song 2.

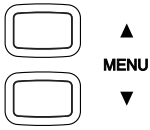

**Press the REC button to enter the song/part selection menu.
Use the MENU buttons to change the song number to Song 2.**

Song2 Part=1
Record J=120

The LCD display shows the song number 2 is selected to be recorded.

When you are ready to record, just start playing the keyboard.

The CN piano will start recording automatically with the first note you play.

Press the PLAY/STOP button when you are finished recording.

RECORDING A SECOND PART

You can record a second part in the second track (part) of the same song. After recording the first part, select the other track and record your second part.

**Press the REC button to enter the song/part selection menu.
Use the MENU buttons to select song 3.**

Song3 Part=1
Record J=120

The LCD display shows the song number 3 is selected to be recorded.

Record the first part just the same as in the previous sections and press the PLAY/STOP button when you're finished recording.

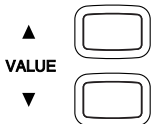

Now press the REC button to enter the song/part menu then select Part 2 to record. Use the VALUE buttons to select part 2.

Song3 Part=2
Record J=120

The LCD display shows the part number 2 is selected to be recorded.

If you want to start recording the second part from the beginning of the song, **just play the keyboard**. You will hear the first part playing back while you record the second part.

If you would like to play back the first part and then start recording the second part from a certain point later in the song, press the PLAY/STOP button instead of playing the keyboard to start playback of the first part and then begin recording the second part from any point you like.

When you are finished recording, press the PLAY/STOP button again.

STATUS OF SONG AND PART

In the LCD display an asterisk (*) after the part number means that the part has been already recorded.

```
Song3 Part=1&2*  
Bar= 1- 1 J=120
```

"" indicates that this part has already been recorded.*

5.2 PLAYING BACK A SONG (PLAY/STOP BUTTON)

The PLAY/STOP button is used to select a song and part to play, and to start and stop play back of the recorded songs.



Press the PLAY/STOP button one time to select a specific song and part you would like to play back. Use the MENU buttons to select a song and use the VALUE buttons to select a part.

```
Song1 Part=1&2*  
Bar= 1- 1 J=120
```

The LCD Display shows that both parts of song 1 are selected to play back

Press the PLAY/STOP button again and the recorded song will start playing.

```
Playing  
Bar= 2- 1 J=120
```

The LCD Display shows that the selected song is playing.

Press the PLAY/STOP button again to stop play back and return to the song select display.

Pressing the REW button rewinds the song and pressing the FF button forwards the song. The bar number and beat number are shown in the display. Press the RESET button to go back to the beginning of the song.

PLAYING BACK THE PARTS SEPARATELY

While you are in the playback menu, use the VALUE buttons to select the desired part number you want to listen to.

```
Song3 Part=2*  
Bar= 1- 1 J=120
```

An asterisk indicates that the part has been recorded.

You can select between, "Part 1", "Part 2", and "Part 1&2". To check that you have recorded on both tracks, select "Part 1", then select "Part 2".

You will see an asterisk after each part, this means you have successfully recorded both parts.

To listen to both parts together select “Part 1&2”.

To play back an individual part, select the desired part using the VALUE button first, then press the PLAY/STOP button to listen.

◆ NOTE

If you don’t see an asterisk after each part you recorded or if your song does not play back correctly, carefully reread the previous section on recording to make sure you’re recording properly. You can use the LCD display to help determine if you have a problem.

USING THE PLAY/STOP BUTTON TO START RECORDING

The PLAY/STOP button can also be used to start recording. In this way, you can insert a blank bar at the beginning of the song.

Press the REC button to enable the piano to record first, then press the PLAY/STOP button. On pressing the PLAY/STOP button, the CN piano starts recording regardless of whether you press a key or not.

5.3 ERASING A SONG

This function allows you to erase any song you do not want to listen to.

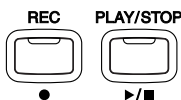

To erase a specific song or part, first press both the REC and PLAY/STOP button. The LCD display will display the erase menu where you select a song or a part to erase.

```
To Del Press REC
SONG1 Part=1&2
```

Select the song and the part to erase.

Use the MENU buttons to select the desired song, and use the VALUE buttons to select the desired part to erase.

Press the REC button to erase. The LCD display will ask you if you’re sure.

```
Sure? Press REC
SONG1 Part=1&2
```

Confirmation to erase the song.

If you are sure you want to erase the song and part, press the REC button again.

If you want to cancel the erase procedure, press the PLAY/STOP button.

```
Deleting
SONG1 Part=1&2
```

The data is being erased (deleted).

ERASING ALL THE SONGS

To erase all the songs at once, first turn off the power then turn it back on again while holding down both the REC and PLAY/STOP buttons.

6. DISK OPERATIONS

The CN4's floppy disk drive provides a convenient way to playback songs recorded in Standard MIDI File (SMF) format. There are many sources of SMF songs, including disks for sale from professional musicians and publishers, songs shared among musicians and hobbyists, and Internet sites that feature SMF songs available for download. Also the Disk Recorder gives you the ability to record on up to 16 independent tracks separately.



Insert a floppy disk in the drive and press the DISK button. The LCD display shows as follows.

```
Disk REC →   UP ▲  
Disk Menu→  DOWN ▼
```

Press the VALUE UP button to go to the Disk Recorder mode.
Press the VALUE DOWN button to go to Disk Menu.

6.1 DISK RECORDER

PLAYING BACK A SONG

If the disk in the drive contains any SMF song data, the LCD display will show the first song/file name on the disk.

```
001 Song  
Bar= 1- 1  J=100
```

The file "001 Song" is selected.

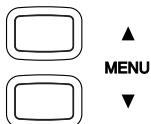

Use the MENU buttons to select other song files.

Press the PLAY/STOP button to playback a song. You can adjust the speed or tempo of the song by using the VALUE buttons while holding down the TEMPO button. The tempo is shown in the display. **Press the PLAY/STOP button again to stop the song.**

Pressing the REW button rewinds the song and pressing the FF button forwards the song. The bar number and beat number are shown in the display. Press the RESET button to go back to the beginning of the song.

A-B LOOP

You can play back a specific part of a song repeatedly. **While playing back a song, press the LOOP button at the point you want to begin the playback from (point A) and press the LOOP button again at the point you want the playback to end (point B).** The recorder will play back the song between point A and B repeatedly until you press the LOOP button again or the PLAY/STOP button to stop.

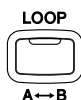

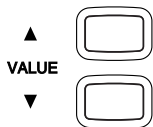

MUTING A PART

You can mute each part separately. **Press one of the VALUE buttons.** The LCD display will show the part mute screen.

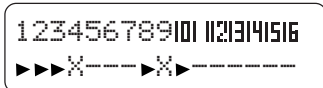

Move the cursor by using the MENU buttons and use the VALUE buttons to switch between play and mute.

- ▶ : The part is played.
- X : The part is muted.
- : The part is empty.

◆ NOTE

The LCD display will automatically return to the previous screen after two seconds if no buttons are pressed.

RECORDING A SONG

You can also record a song with up to 16 parts on a floppy disk. **Insert a floppy disk in the drive and press the DISK button. Press the VALUE UP button to go to the Disk Recorder mode.** If the disk is empty, then an empty song will automatically be selected and the LCD display will show “EmptySong”.

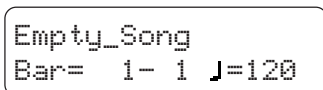

“EmptySong” is selected.

◆ NOTE

If the disk already contains any song files, after the first file is selected pressing the MENU DOWN button will select “EmptySong”.

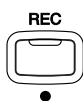

Press the REC button. The LCD display will show the part selection screen.

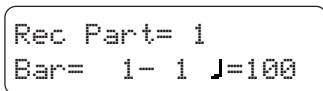

The LCD display shows which part will be recorded.

Use the VALUE buttons to select a part to record.

◆ NOTE

Part 10 is reserved as the Drum track. When you select Part 10, you can record Drum sounds only. Drum sounds can only be recorded on Part 10, you can not choose Drum Sounds to be recorded on any other part.

◆ NOTE

When the Rec Part is set to MIDI, any MIDI data coming in via MIDI IN jack is recorded in Parts 1 through 16 according to MIDI channel.

Start recording by playing the keyboard or by pressing the PLAY/STOP button. When you are finished recording, press the PLAY/STOP again button to stop.

To continue recording other parts, Press the REC button again and use the VALUE buttons to select another part to record. If an asterisk (*) appears after the part number, that part has already been recorded. If you record on a part that has already been recorded your new recording will completely erase the previous recording on that part.

```
Rec Part= 1*  
Bar= 1- 1 J=120
```

Part 1 is already recorded.

ADJUSTING THE VOLUME LEVEL OF THE DISK RECORDER

This is useful for balancing the volume when you play the CN piano along with a song from the Disk Recorder.

Press and hold the DISK button. The LCD display will show the total volume screen.

```
Disk Recorder  
Total Volume=100
```

Use the VALUE buttons to adjust the volume level of Disk Recorder. The value can be changed from 0 to 100.

SAVING THE RECORDED SONG TO THE DISK

When you select another song, or press the DISK button to exit the Disk Recorder, the CN piano will ask you if you want to save the recorded song to the disk.

```
Save to Disk?  
Yes→REC No→STOP
```

Press the REC button to save the recorded song to the disk. The LCD display will show the Song Name screen.

```
SongName  
NEWSONG001 →REC
```

To name the song, move the cursor by using the MENU buttons and choose a character by using the VALUE buttons.

After you have named the song, press the REC button again to save the song. The LCD display will show “Executing...” and then “Complete!”.

If you do not want to save the song, press the STOP button and the recorded song data will be erased.

6.2 DISK MENU

To access the Disk Menu, make sure you have a floppy disk in the drive then press the DISK button. Press the VALUE DOWN button to go to the Disk Menu. There are five functions in the Disk Menu. Use the MENU buttons to select the various functions and press one of the VALUE buttons to enter the selected Disk function.

1. INTERNAL SONG SAVE

You can save a song recorded in the CN’s internal recorder to a floppy disk.

Select the song you want to save by using the VALUE buttons and press the REC button.

```
Int Song Save
Song1      →REC
```

Song1 is selected.

To name the song, move the cursor by using the MENU buttons and choose a character by using the VALUE buttons.

```
Int Song Rename
NewSong    →REC
```

The song is renamed as “NewSong”.

After you have named the song, press the REC button again to save the internal song to disk. The LCD display will show “Executing...” and then “Complete!”.

2. SONG RENAME

You can change the name of a song in the floppy disk.

Select a song you want to rename by using the VALUE buttons and press the REC button.

```
Disk Song Rename
Song1      →REC
```

Song1 is selected.

To rename the song, move the cursor by using the MENU buttons and choose a character by using the VALUE buttons.

```
Disk Song Rename
Song2      →REC
```

The song is renamed as "Song2".

After you have renamed the song, press the REC button again to save the renamed song to disk. The LCD display will show "Executing..." and then "Complete!".

3. SONG DELETE

You can delete a song from the floppy disk.

Select the song you want to delete by using the VALUE buttons and press the REC button.

```
Disk Song Delete
Song1      →REC
```

Song1 is selected.

The LCD display will ask you for confirmation.

```
Sure?
Yes→REC  No→STOP
```

If you want to cancel, press the PLAY/STOP button. Press the REC button to delete the song. The LCD display will show "Executing..." and then "Complete!".

4. SONG COPY

You can make a copy of a song on the same floppy disk or copy a song to another floppy disk.

Select the song you want to copy by using the VALUE buttons and press the REC button.

```
Disk Song Copy
Song1      →REC
```

Song1 is selected.

The LCD display will show "Reading..." and then show "Write to Disk?".

```
Write to Disk?
Song001     →REC
```

If you want to copy the song to another disk, simply remove the floppy Disk from the drive and insert the new floppy disk you want

to copy the song to. To rename the song, move the cursor by using the MENU buttons and choose a character by using the VALUE buttons. After you have renamed the song, press the REC button again to save the renamed song to disk. The LCD display will show “Executing...” and then “Complete!”.

5. DISK FORMAT

The CN4 disk drive is compatible with 3.5” 2HD or 2DD floppy disks formatted to the Dos/V format (Windows format). If you want to use a floppy disk that does not conform to this format with the CN4 you must first format the disk. Formatting a disk will erase all of the data on the disk.

Insert the floppy disk to be formatted in the drive and select the disk type by using the VALUE buttons.

```
Format Disk 2HD ▲  
                2DD ▼
```

Press the REC button and the LCD display will ask you for confirmation.

```
Format Disk 2HD  
Yes→REC No→STOP
```

Press the REC button to format the disk. The LCD display will show “Formatting...” and then “Complete!”.

7. TOUCH, TRANSPOSE AND MENU FUNCTIONS

7.1 TOUCH

Touch lets you select a different touch sensitivity for the keyboard from the standard touch of an acoustic piano. You can change the sensitivity to one of five different settings: Light, Light+, Heavy, Heavy+ and Off.

- Light** For those still developing finger strength. A louder volume is produced even when playing with a soft touch.
- Light+** For players with a delicate touch. Requires less striking force to achieve a forte note.
- Heavy** Perfect for those with strong fingers. Requires a heavier touch to produce a loud volume.
- Heavy+** Requires more striking force to achieve a loud volume.
- Off** A constant volume is produced regardless of how hard the keys are struck. This setting is suitable for sounds that have a fixed dynamic range such as Organ and Harpsichord.



To change from the standard touch, **press the TOUCH button**. The LED indicator above the TOUCH button will be turned on to indicate that the piano is now using a different touch setting.

To select the Touch type, **press and hold the TOUCH button**. The LCD display will show the currently selected touch type.

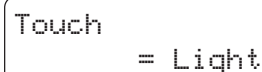

Touch
= Light

The LCD display shows the touch type currently selected.

Use the VALUE buttons to change the Touch type.

Press the TOUCH button again to get back to the standard touch setting.

Touch selection is global for all the preset tones. You can not have an individual setting for each tone.

◆ NOTE

LIGHT and HEAVY do not represent the physical weight of the keys. These are settings that affect the sensitivity of the keys, which determines the volume level in response to the key movement.

7.2 TRANSPOSE

The transpose function lets you raise or lower the piano's key in half steps. This is especially useful when you have learned a song in one key and have to play it in another key. The transpose feature allows you to play the song in the original key, but hear it in another key.



Press and hold the TRANSPOSE button.

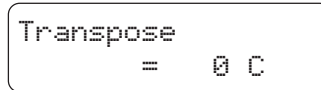

*The LCD display shows you the current value.
The value is always set to "0" when the power is turned on.*

While still holding the TRANSPOSE button, use the VALUE buttons or the keyboard from C3 to C5 to specify the transposition amount.

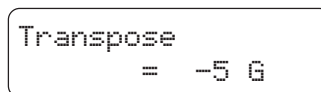

The LCD display shows you a number telling you how many half steps up or down you have transposed the piano. -5, for example, represents a transposition that is 5 half steps lower. "0" indicates no transposition.

The piano can be transposed up to 12 half steps higher or 12 half steps lower.

Pressing TRANSPOSE button again turns the TRANSPOSE function off.

The TRANSPOSE function remembers the current setting as long as the power is on.

7.3 MENU BUTTONS

These buttons are used to access the various functions that control the CN piano's tuning, system and MIDI functions. They are:

1. Brilliance
2. Lower Octave Shift
3. Lower Pedal On/Off
4. Layer Octave Shift
5. Layer Dynamics
6. Damper Hold
7. Tuning
8. Temperament
9. Key of Temperament
10. MIDI Channel
11. Local Control On/Off
12. Transmit Program Change On/Off
13. Sending Program Change Numbers
14. Multi-Timbral Mode On/Off
15. Channel Mute (MIDI Ch. On/Off)
16. MIDI Clock
17. User Memory
18. Factory Reset

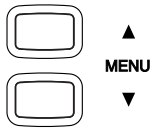

COMMON OPERATION

To select a function that you want to adjust, press either of the MENU buttons. The LCD will display “1 Brilliance”, the first item in the menu.

```
1 Brilliance
  = +3
```

Press the MENU buttons again to select a different function to edit.

Use the VALUE buttons to change value.

To exit the function menu, press any SOUND SELECT button.

◆ NOTE

Once the power is turned off, all settings will be reset to the factory preset values unless you use the “User Memory” function to save your current settings. For more information about the “User Memory” function please see page 43 in this section of the manual.

1. BRILLIANCE

Brilliance lets you adjust brightness of the preset sounds.

After selecting the “Brilliance” function by pressing the MENU buttons, use the VALUE buttons to change the value to the desired amount.

```
1 Brilliance
  = +3
```

The LCD display shows the brilliance setting with a number. “0” indicates the standard setting.

Brilliance can be set between -10 to +10. Plus settings produce a brighter tone, minus settings produce a mellower tone.

Brilliance settings are global for all the preset sounds. You can not have an individual setting for each sound.

2. LOWER OCTAVE SHIFT

This allows the octave of the lower part to be shifted up one, two, or three octaves higher when you use the split function.

After selecting the “Lower Octave Shift” function by pressing the MENU buttons, use the VALUE buttons to select your desired shift range.

```
2 LowerOctShift
  = 1
```

The LCD display shows the lower part is shifted one octave up.

Lower Octave Shift can be set between 0 to 3.

3. LOWER PEDAL ON/OFF

This determines if the sustain pedal will be active for lower sound when in SPLIT mode. The default setting is Off which means the sustain pedal is not active for the lower sound.

After selecting the “Lower Pedal” function by pressing the MENU buttons, use the VALUE buttons to turn it on and off.

```
3 Lower Pedal
  = On
```

The LCD display shows whether Lower Pedal is on or off.

4. LAYER OCTAVE SHIFT

This allows the octave of the layered part to be shifted up or down when you use the dual function.

After selecting the “Layer Octave Shift” function by pressing the MENU buttons, use the VALUE buttons to select your desired shift range.

```
4 LayerOctShift
  = 1
```

The LCD display shows the layered part is shifted one octave up.

Layer Octave Shift can be set between -2 to 2.

5. LAYER DYNAMICS

In Dual mode sometimes simply adjusting the volume balance between the two layered sounds is not enough to create the desired sound character if both sounds are very dynamic. Two equally dynamic sounds can be difficult to control and play comfortably. The Layer Dynamics function allows you to limit the overall dynamic sensitivity of the layered sound to create a perfect blend between both sounds in a layer. In addition to reducing the volume of the layered sound, limiting the dynamic sensitivity of the layered sound also makes the layered sound easier to control in relation to the main sound as you play. With this function, you can comfortably play as dynamically as you like with the main sound while maintaining control of the layered sound.

After selecting the “Layer Dynamics” function by pressing the

MENU buttons, use the VALUE buttons to select the desired Dynamics level.



5 LayerDynamics
= 10

The LCD display shows the dynamics of the layered sound is 10 (dynamics of the layered sound are unchanged).

You can select the level of dynamics from 1 to 10. A value of 1 produces the greatest reduction in dynamics and a value of 10 produces no change in the dynamics. The default value is 10.

6. DAMPER HOLD

This determines if the sound such as organ or strings should be held (on) or gradually decayed (off) when the damper pedal is depressed.

After selecting the “Damper Hold” function by pressing the MENU buttons, use the VALUE buttons to turn it on and off.



6 Damper Hold
= Off

The LCD display shows the damper hold is off.

The default setting is off.

7. TUNING

Tuning allows you to adjust the piano’s pitch. You may need to adjust the tuning when you play with other instruments.

After selecting the “Tuning” function by pressing the MENU buttons, use the VALUE buttons to adjust the tuning.

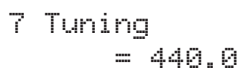

7 Tuning
= 440.0

The LCD display shows the current pitch setting.

The LCD display shows the pitch for “A” in Hz (Hertz). The range of adjustment is from 427.0 to 453.0 Hz. The factory preset value is set to the modern standard A = 440.0 Hz.

8. TEMPERAMENT

The CN piano offers not only equal temperament (the modern standard) but also immediate access to temperaments popular during the Renaissance and Baroque periods. It should be interesting and educational to try some of the different temperaments, although the equal temperament is dominant today.

After Selecting the “Temperament” function by pressing the MENU buttons, use the VALUE buttons to select your desired temperament.

8 Temperament
= Equal(P.only)

The LCD display shows the type of temperament currently selected.

BRIEF EXPLANATION OF TEMPERAMENTS

8 Temperament
= Equal(P.only)

EQUAL TEMPERAMENT (PIANO ONLY)

This is the default temperament. If a piano sound is selected the tuning is stretched like an acoustic piano (EQUAL TEMPERAMENT). If any other type of sound is selected the tuning will be EQUAL (FLAT). An explanation of EQUAL TEMPERAMENT and EQUAL TEMPERAMENT (FLAT) is provided later in this section.

◆ NOTE

If a piano sound is used in a layer with any other sound then both sounds will use the EQUAL TEMPERAMENT (Stretched) tuning.

8 Temperament
= Pure(Major)

MERSENNE PURE TEMPERAMENT (MAJOR)

MERSENNE PURE TEMPERAMENT (MINOR)

This temperament, which eliminates dissonance's for thirds and fifths is still popular for choral music because of its perfect harmony.

8 Temperament
= Pure(minor)

You need to be aware what key you are playing in with this temperament. Any key modulation will result in dissonance's. When you play music in a particular key, you need to match the key of the temperament as well. When playing in a major key select Pure (Major) and when playing in a minor key select Pure (minor).

8 Temperament
= Pythagorean

PYTHAGOREAN TEMPERAMENT

This temperament, which uses mathematical ratios to eliminate dissonance for fifths, is very limited for use with chords, but it produces very characteristic melodic lines.

8 Temperament
= Meantone

MEANTONE TEMPERAMENT

This temperament, which uses a mean between a major and minor whole tone to eliminate dissonance for thirds, was devised to eliminate the lack of consonance's experienced with certain fifths for the Mersenne pure temperament. It produces chords that are more beautiful than those with the equal temperament.

```
8 Temperament
= Werckmeister
```

```
8 Temperament
= Kirnberger
```

WERCKMEISTER III TEMPERAMENT KIRNBERGER III TEMPERAMENT

These two temperaments are placed in between Meantone and Pythagorean. For music with few accidentals, this temperament produces the beautiful chords of the mean tone, but as accidentals increase, the temperament produces the characteristic melodies of the Pythagorean temperament. It is used primarily for classical music written in the Baroque era to revive the original characteristics.

```
8 Temperament
= Equal(flat)
```

EQUAL TEMPERAMENT (FLAT)

This is “unstretched” equal temperament that divides the scale into twelve equal semitones. This produces the same chordal intervals in all twelve keys, and has the advantage of limitless modulation of the key. However the tonality of each key becomes less characteristic and no chord is in pure consonance.

```
8 Temperament
= Equal
```

EQUAL TEMPERAMENT

This is the most popular piano temperament. The hearing ability of a human is uneven and is not as accurate with high frequency and low frequency as it is with the middle range. This temperament’s tuning is stretched to compensate for this so the sound will be heard naturally to the ears. This “Stretched” equal temperament is a practical variation of the “unstretched” equal temperament which was invented on a mathematical basis.

◆ NOTE

After you have selected the desired temperament, please read the following section on selecting a key signature for the temperament before continuing.

9. KEY OF TEMPERAMENT

Limitless modulation of the key became available only after the invention of Equal temperament. When we use a temperament other than Equal temperament, we must carefully choose the key signature to play in. For example, if the song you are going to play is written in D major, choose “D” as the temperament key.

After selecting the “Key Signature” function by pressing the MENU buttons, use the VALUE buttons to set the desired key.

```
9 Key of Temper
= C
```

The LCD display shows the currently selected key signature .

Please note that changing the key of the temperament will only change the “balance” of the tuning, the pitch of the keyboard remains unchanged.

Use the TUNING or TRANSPOSE functions to change the pitch of the whole keyboard.

◆ NOTE

This function is not displayed when Equal temperament is selected.

10. MIDI CHANNEL

This determines on which MIDI channel the CN piano will exchange MIDI information with an external MIDI instrument or a personal computer.

After selecting the “MIDI Channel” function by pressing the MENU buttons, use the VALUE buttons to select your desired number.

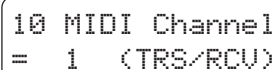

```
10 MIDI Channel
= 1 (TRS/RCV)
```

The LCD display shows the currently selected channel number.

11. LOCAL CONTROL ON/OFF

This determines whether the CN piano’s sound will be played from the piano’s keyboard (“ON”) or only from an external MIDI instrument (“OFF”).

Even with local control “off” the piano’s keyboard will still transmit to an external MIDI instrument or personal computer.

After selecting the “Local Control” function by pressing the MENU buttons, use the VALUE buttons to turn on and off.

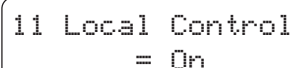

```
11 Local Control
= On
```

The LCD display shows whether Local Control is on or off.

12. TRANSMIT PROGRAM CHANGE ON/OFF

This determines whether or not the CN piano will transmit program change information when pressing the SOUND SELECT buttons. When this is turned on, pressing the SOUND SELECT buttons will send the program change numbers as listed in page 48-55.

After selecting the “Transmit PGM” function by pressing the MENU buttons, use the VALUE buttons to turn it on and off.

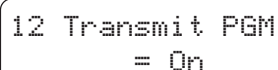

```
12 Transmit PGM
= On
```

The LCD display shows whether or not program change numbers will be transmitted.

13. SENDING PROGRAM CHANGE NUMBERS

This function allows the CN piano to transmit program change numbers. You can send any number from 1 to 128.

After selecting the “Send PGM #” function by pressing the MENU buttons, use the VALUE buttons to select your desired number.



13 Send PGM #
= 124 (UP+DOWN)

The LCD display shows the program change number.

To send the program change number, press both VALUE buttons simultaneously.

14. MULTI-TIMBRAL MODE

Multi-timbral mode allows the CN piano to receive data on more than one MIDI channel simultaneously. In this mode, the CN piano can play different musical parts with different sounds for each part.

Multi-Timbral On (On1 and On2)

This is a flexible 16 part multi-timbral setup. You can turn individual MIDI channels on and off, and assign any program number to any channel in the way you like. The CN piano’s normal program change numbers are assigned in On1 and General MIDI program change numbers are assigned in On2. (Please see page 48-55 for a list of the program change numbers.)

Multi-Timbral Off

This turns off the multi-timbral capability. Only one MIDI channel will be active and only the preset sound currently selected will be heard when a MIDI signal is received.

After selecting the “Multi-Timbre” function by pressing the MENU buttons, use the VALUE buttons to turn it on and off.

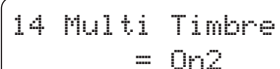

14 Multi Timbre
= On2

The LCD display shows the selected Multi-timbral mode.

15. CHANNEL MUTE

This determines which MIDI channels are activated to receive MIDI information when the Multi-Timbral mode is set to on. You can activate or deactivate each of the 16 channels individually.

Select the “Channel Mute” function by pressing the MENU buttons. Keep pressing the MENU buttons to select each of the sixteen channels

```
15 Channel Mute
Channel 1= Play
```

The LCD display shows the selected MIDI channel number.

Use the VALUE buttons to switch between PLAY and MUTE.

```
15 Channel Mute
Channel 1= Mute
```

Select “Play” to turn the channel on or “Mute to turn it off.

◆ **NOTE**

When the Multi-timbral mode is set to off, the “Channel Mute” function will not be displayed in the function menu.

16. MIDI CLOCK

MIDI Clock is a data code that a MIDI instrument uses as the reference for its Tempo setting. When it is set to Internal, the CN piano uses its own built-in clock to control tempo settings. When set to External, the CN piano reads the clock data it receives via MIDI and uses this data to control the Tempo.

After selecting the “MIDI Clock” function by pressing the MENU buttons, use the VALUE buttons to select the desired setting.

```
16 MIDI Clock
= Int.
```

The LCD display shows the selected MIDI Clock source.

17. USER MEMORY

This function allows the CN piano to save the user-definable settings when the power is turned off. Once written to the memory, the saved settings will be recalled every time you turn the power on.

The following settings can be saved—Effect settings, Metronome settings (tempo, time signature and volume), starting sound, primary sound for each sound category and the menu functions 1 through 16 described in the previous pages.

Select the “User Memory” function by pressing the MENU buttons.

```
17 User Memory
Save →Press REC
```

Press the REC button to memorize your desired settings.

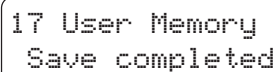

17 User Memory
Save completed

The LCD display briefly shows the above message and the current settings are saved.

◆ **NOTE**

The “User Memory” function does not automatically save any changes made to the settings every time the power is turned off. You must use the User Memory function each time you want to save your current settings.

18. FACTORY RESET

This function resets the CN piano to the factory settings. All parameters you saved in “User Memory” will be reset to the factory preset values.

Select the “Factory Reset” function by pressing the MENU buttons.

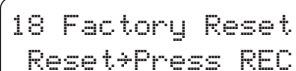

18 Factory Reset
Reset→Press REC

Press the REC button to reset the CN piano.

◆ **NOTE**

SONG data in RECORDER, User Touch and User Temperament will not be reset by this function.

8. USING MIDI

The term MIDI is an acronym for Musical Instrument Digital Interface, an international standard for connecting synthesizers, sequencers (MIDI recorders) and other electronic instruments so that they can exchange performance data.

The CN4 is equipped with three MIDI jacks for exchanging data: MIDI IN, MIDI OUT and MIDI THRU. Each uses a special cable with a DIN connector.

MIDI IN : For receiving note, program change and other data.

MIDI OUT : For sending note, program change and other data.

MIDI THRU : For passing along MIDI data received to another MIDI instrument without processing.

MIDI EXAMPLES

(1) Connection to another MIDI compatible keyboard or sound generator module

When connected as shown in the illustration, data on how the digital piano is played (which keys are struck) can be sent to another MIDI instrument. Plus, the sound from the CN4 can be layered over the sound of the other instrument.

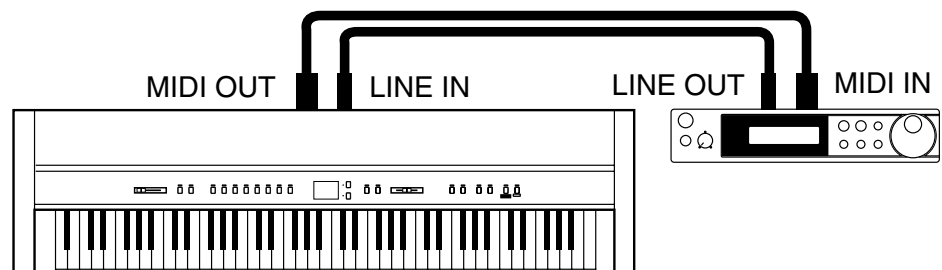

(2) Connection to an external sequencer

When connected as shown in the illustration, you can record songs played on the CN4 with a MIDI recorder, and use the CN4's tones (such as piano, harpsichord and vibraphone, etc.) controlled by the CN4's MULTI-TIMBRAL MODE function to create a multi-layer MIDI recording.

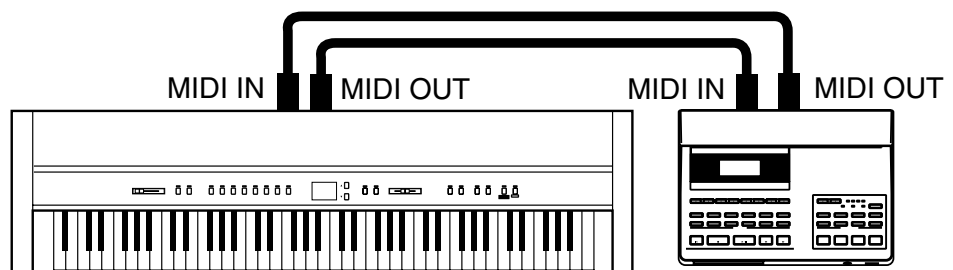

9. JACKS

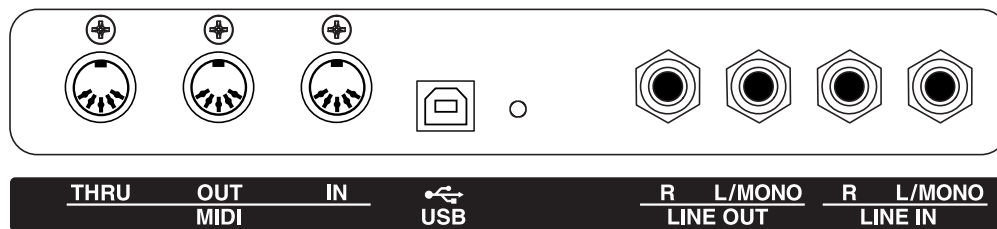

MIDI JACKS

These jacks are used to connect external MIDI devices with the CN piano. There are three terminals: MIDI IN, MIDI OUT, and MIDI THRU.

USB JACK

This jack is used to connect with a personal computer and exchange MIDI data.

LINE OUT JACKS

These jacks provide stereo output of the piano's sound to amplifiers, tape recorders or similar equipment.

The audio signal coming through the LINE IN jacks is also routed to these jacks. The piano's sound is mixed with the LINE IN signals.

The CN piano's VOLUME slider can control the output level of its own sound while it does not control the LINE IN signal.

LINE IN JACKS

These jacks are used to connect a pair of stereo outputs from other audio equipment or electronic instruments to the piano's speakers.

The audio signal coming through these jacks bypasses the piano's volume control. To adjust the volume level, use the output control of the external device.

HEADPHONE JACKS

There are two jacks for headphones provided at the left end on the bottom of the piano.

You can hear the piano's sound as well as any audio signal that is coming through the LINE IN.

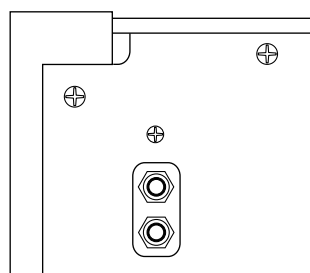

BOTTOM VIEW

NOTES ABOUT USB

The CN piano can be connected with a personal computer with a USB cable for exchanging MIDI data. You need a USB driver installed in your computer.

[For Windows XP/Me users]

A standard USB driver is already installed in your computer. You don't need to install a new driver.

[For Windows 2000/98SE users]

You need to install the designated driver in your computer. Visit the KAWAI web site at <http://www.kawai.co.jp/english/Download1.html> and download the program.

[For Macintosh users]

Macintosh OSX automatically recognizes our USB interface. No special driver is needed. Older Macintosh OS are not supported by us. If you have an older Macintosh OS, please use an appropriate MIDI interface and MIDI cables when connecting the CN piano to a Macintosh computer.

NOTE:

When both MIDI jacks and USB jack are connected, USB has priority.

When connecting USB cable to the CN piano, first connect the USB cable and then turn the power of the CN piano on.

It may take some time to start communication when the CN piano is connected to the computer via USB.

When USB communication is unstable with connection via hub, connect the USB cable directly to the USB port of the computer.

Turning the power of CN piano on/off or disconnecting the USB cable while the following actions may cause unstable communication.

- while installing USB driver
- while booting up the computer
- while MIDI application is working
- while communicating with the computer
- while the computer is in energy saver mode

* If you have any problem with USB communication, consult the instruction manual of your computer and check your computer set up.

* The USB-MIDI conversion board TID10000934 used in the CN piano is approved to show the USB logo. The USB logo can be used only for the product which is approved by USB-IF (USB Implements Forum Inc.) test.

* Windows is registered trademark of Microsoft Corporation.

* Macintosh is registered trademark of Apple Computer, Inc.



10. APPENDICES

PROGRAM CHANGE NUMBER MAPPING

Sound	Multi-Timbral mode				
	Off, On 1		On 2		
	Bank LSB	Prog #	Bank MSB	Bank LSB	Prog #
Concert Grand	0	1	121	0	1
Studio Grand	0	2	121	1	1
Mellow Grand	0	3	121	2	1
Jazz Grand	0	4	95	8	1
Modern Piano	0	5	121	0	2
Honky Tonk	0	6	121	0	4
Rock Piano	0	7	121	1	2
New Age Piano	0	8	95	9	1
Classic E.P.	0	9	121	0	5
Modern E.P.	0	10	121	0	6
60's E.P.	0	11	121	3	5
Modern E.P. 2	0	12	121	1	6
Jazz Organ	0	13	121	0	18
Drawbar Organ	0	14	121	0	17
Drawbar Organ 2	0	15	121	1	17
Be 3	0	16	95	2	17
Church Organ	0	17	121	0	20
Diapason	0	18	95	7	20
Full Ensemble	0	19	95	1	21
Principal Oct.	0	20	95	24	20
Harpsichord	0	21	121	3	7
Vibraphone	0	22	121	0	12
Clavi	0	23	121	0	8
Harpsichord Oct.	0	24	121	1	7
Slow Strings	0	25	95	1	45
String Pad	0	26	95	8	49
Warm Strings	0	27	95	1	49
String Ensemble	0	28	121	0	49
Choir	0	29	121	0	53
New Age	0	30	121	0	89
Atmosphere	0	31	121	0	100
Itopia	0	32	121	1	92
Wood Bass	0	33	121	0	33
Electric Bass	0	34	121	0	34
Fretless Bass	0	35	121	0	36
W. Bass & Ride	0	36	95	1	33
New Age Piano 2	0	37	95	10	1
New Age Piano 3	0	38	95	11	1
Piano Octaves	0	39	95	1	1
Electric Grand	0	40	121	0	3

Sound	Multi-Timbral mode				
	Off, On 1		On 2		
	Bank LSB	Prog #	Bank MSB	Bank LSB	Prog #
Electric Grand 2	0	41	121	1	3
Wide Honky Tonk	0	42	121	1	4
Dolce E.P.	0	43	95	2	5
Crystal E.P.	0	44	95	1	6
Tremolo E.P.	0	45	95	1	5
Classic E.P. 2	0	46	121	1	5
Classic E.P. 3	0	47	121	2	5
New Age E.P.	0	48	95	2	6
Modern E.P. 3	0	49	121	2	6
Legend E.P.	0	50	121	3	6
Phase E.P.	0	51	121	4	6
Harpichord 2	0	52	121	0	7
Wide Harpichord	0	53	121	2	7
Synth Clavi	0	54	121	1	8
Celesta	0	55	121	0	9
Glockenspiel	0	56	121	0	10
Music Box	0	57	121	0	11
Wide Vibraphone	0	58	121	1	12
Marimba	0	59	121	0	13
Wide Marimba	0	60	121	1	13
Xylophone	0	61	121	0	14
Hand Bells	0	62	95	1	15
Tubular Bells	0	63	121	0	15
Church Bells	0	64	121	1	15
Carillon	0	65	121	2	15
Dulcimer	0	66	121	0	16
Soft Solo	0	67	95	8	17
Drawbar Organ 3	0	68	95	1	17
Jazzier	0	69	95	1	18
Hi-Lo	0	70	95	3	17
Drawbar Organ 4	0	71	121	3	17
Electronic Organ	0	72	95	9	17
60's Organ	0	73	121	2	17
Perc. Organ	0	74	121	1	18
Perc. Organ 2	0	75	121	2	18
Tibia Bass	0	76	95	14	18
Rock Organ	0	77	121	0	19
Theater Organ	0	78	95	1	20
8' Celeste	0	79	95	5	20
Small Ensemble	0	80	95	8	20
Reeds	0	81	95	10	20
Chiffy Tibia	0	82	95	17	20
Principal Pipe	0	83	95	22	20
Church Organ 2	0	84	121	1	20

Multi-Timbral mode					
Sound	Off, On 1		On 2		
	Bank LSB	Prog #	Bank MSB	Bank LSB	Prog #
Church Organ 3	0	85	121	2	20
Reed Organ	0	86	121	0	21
Puff Organ	0	87	121	1	21
French Accordion	0	88	121	0	22
Fr. Accordion 2	0	89	95	1	22
Accordion	0	90	121	1	22
Accordion 2	0	91	95	2	22
Blues Harmonica	0	92	95	2	23
Harmonica	0	93	121	0	23
Tango Accordion	0	94	121	0	24
Finger Nylon Gtr	0	95	95	4	25
Nylon Acoustic	0	96	121	0	25
Nylon Acoustic 2	0	97	121	2	25
Nylon Acoustic 3	0	98	121	3	25
Ukulele	0	99	121	1	25
Steel Guitar	0	100	121	0	26
Steel Guitar 2	0	101	121	3	26
12 String	0	102	121	1	26
Mandolin	0	103	121	2	26
Jazz Guitar	0	104	121	0	27
Pedal Steel	0	105	121	1	27
Rhythm Guitar	0	106	121	2	28
Electric Guitar	0	107	121	0	28
E. Guitar 2	0	108	121	1	28
E. Guitar 3	0	109	121	2	29
Muted Electric	0	110	121	0	29
Cutting Guitar	0	111	121	1	29
Country Lead	0	112	121	3	29
Overdrive Guitar	0	113	121	0	30
Dynamic Ov. drive	0	114	121	1	30
Distortion	0	115	121	0	31
Dist Feedback	0	116	121	1	31
Dist Rhythm	0	117	121	2	31
E. Gtr Harmonics	0	118	121	0	32
Guitar Feedback	0	119	121	1	32
Wood Bass 2	0	120	95	5	33
Fingerslap Bass	0	121	121	1	34
Pick Bass	0	122	121	0	35
Slap Bass	0	123	121	0	37
Slap Bass 2	0	124	121	0	38
Synth Bass	0	125	121	0	39
Synth Bass 2	0	126	121	0	40
Synth Bass 3	0	127	121	2	39
Synth Bass 4	0	128	121	1	40

Sound	Multi-Timbral mode				
	Off, On 1		On 2		
	Bank LSB	Prog #	Bank MSB	Bank LSB	Prog #
Warm Synth Bass	1	1	121	1	39
Clavi Bass	1	2	121	3	39
Hammer Bass	1	3	121	4	39
Rubber Bass	1	4	121	2	40
Attack Bass	1	5	121	3	40
Violin	1	6	121	0	41
Slow Violin	1	7	121	1	41
Viola	1	8	121	0	42
Cello	1	9	121	0	43
Contrabass	1	10	121	0	44
Tremolo Strings	1	11	121	0	45
Strings & Brass	1	12	121	1	49
60's Strings	1	13	121	2	49
String Ensemble 2	1	14	121	0	50
Synth Strings	1	15	121	0	51
Synth Strings 3	1	16	121	1	51
Synth Strings 2	1	17	121	0	52
Pizzicato	1	18	121	0	46
Harp	1	19	121	0	47
Celtic Harp	1	20	121	1	47
Timpani	1	21	121	0	48
Choir Aahs 2	1	22	121	1	53
Voice Oohs	1	23	121	0	54
Humming	1	24	121	1	54
Synth Vocal	1	25	121	0	55
Analog Voice	1	26	121	1	55
Orchestra Hit	1	27	121	0	56
Bass Hit Plus	1	28	121	1	56
6th Hit	1	29	121	2	56
Euro Hit	1	30	121	3	56
Trumpet	1	31	121	0	57
Solo Trumpet	1	32	121	1	57
Flugel Horn	1	33	95	1	57
Sentimental Bone	1	34	95	7	58
Trombone	1	35	121	0	58
Trombone 2	1	36	121	1	58
Bright Trombone	1	37	121	2	58
Tuba	1	38	121	0	59
Cup Mute Trumpet	1	39	95	1	60
Cup Mute Trombone	1	40	95	2	60
Muted Trumpet	1	41	121	0	60
Muted Trumpet 2	1	42	121	1	60
French Horns	1	43	121	0	61
Warm French Horn	1	44	121	1	61

Sound	Multi-Timbral mode				
	Off, On 1		On 2		
	Bank LSB	Prog #	Bank MSB	Bank LSB	Prog #
Brass Section	1	45	121	0	62
Brass Section 2	1	46	121	1	62
Synth Brass	1	47	121	0	63
Synth Brass 3	1	48	121	1	63
Synth Brass 2	1	49	121	0	64
Synth Brass 4	1	50	121	1	64
Jump Brass	1	51	121	3	63
Analog Brass	1	52	121	2	63
Analog Brass 2	1	53	121	2	64
Oboe & Strings	1	54	95	5	69
Soprano Sax	1	55	121	0	65
Alto Sax	1	56	121	0	66
Soft Tenor Sax	1	57	95	2	67
Tenor Sax	1	58	121	0	67
Baritone Sax	1	59	121	0	68
Oboe	1	60	121	0	69
English Horn	1	61	121	0	70
Bassoon	1	62	121	0	71
Clarinet	1	63	121	0	72
Flute & Strings	1	64	95	8	74
Piccolo	1	65	121	0	73
Jazz Flute	1	66	95	1	74
Big Band Winds	1	67	95	2	74
Orchestral Winds	1	68	95	3	74
Flute	1	69	121	0	74
Ballad Flute	1	70	95	13	74
Recorder	1	71	121	0	75
Pan Flute	1	72	121	0	76
Blown Bottle	1	73	121	0	77
Shakuhachi	1	74	121	0	78
Whistle	1	75	121	0	79
Ocarina	1	76	121	0	80
Square	1	77	121	0	81
Square 2	1	78	121	1	81
Sine	1	79	121	2	81
Classic Synth	1	80	121	0	82
Classic Synth 2	1	81	121	1	82
Lead	1	82	121	2	82
Classic Synth 3	1	83	121	3	82
Sequenced Analog	1	84	121	4	82
Caliope	1	85	121	0	83
Chiff	1	86	121	0	84
Charang	1	87	121	0	85
Wire Lead	1	88	121	1	85

Multi-Timbral mode					
Sound	Off, On 1		On 2		
	Bank LSB	Prog #	Bank MSB	Bank LSB	Prog #
Voice	1	89	121	0	86
Fifth	1	90	121	0	87
Bass & Lead	1	91	121	0	88
Soft Wire Lead	1	92	121	1	88
New Age 2	1	93	95	1	89
New Age 3	1	94	95	2	89
New Age 4	1	95	95	3	89
Warm Pad	1	96	121	0	90
Sine Pad	1	97	121	1	90
Polysynth	1	98	121	0	91
Choir	1	99	121	0	92
Bowed	1	100	121	0	93
Metallic	1	101	121	0	94
Halo	1	102	121	0	95
Sweep	1	103	121	0	96
Rain Pad	1	104	121	0	97
Soundtrack	1	105	121	0	98
Crystal	1	106	121	0	99
Synth Mallet	1	107	121	1	99
Brightness	1	108	121	0	101
Goblin	1	109	121	0	102
Echoes	1	110	121	0	103
Echo Bell	1	111	121	1	103
Echo Pan	1	112	121	2	103
Sci-Fi	1	113	121	0	104
Sitar	1	114	121	0	105
Sitar 2	1	115	121	1	105
Banjo	1	116	121	0	106
Shamisen	1	117	121	0	107
Koto	1	118	121	0	108
Taisho Koto	1	119	121	1	108
Kalimba	1	120	121	0	109
Bag Pipe	1	121	121	0	110
Fiddle	1	122	121	0	111
Shanai	1	123	121	0	112
Tinkle Bell	1	124	121	0	113
Agogo	1	125	121	0	114
Steel Drums	1	126	121	0	115
Woodblock	1	127	121	0	116
Castanet	1	128	121	1	116
Taiko Drums	2	1	121	0	117
Concert BD	2	2	121	1	117
Melodic Toms	2	3	121	0	118
Melodic Toms 2	2	4	121	1	118

Sound	Multi-Timbral mode				
	Off, On1		On 2		
	Bank LSB	Prog #	Bank MSB	Bank LSB	Prog #
Synth Drum	2	5	121	0	119
Rhythm Box Tom	2	6	121	1	119
Electric Drum	2	7	121	2	119
Reverse Cymbal	2	8	121	0	120
Gtr Fret Noise	2	9	121	0	121
Gtr Cutting Noise	2	10	121	1	121
Ac Bass Slap	2	11	121	2	121
Breath Noise	2	12	121	0	122
Flute Key Click	2	13	121	1	122
Seashore	2	14	121	0	123
Rain	2	15	121	1	123
Thunder	2	16	121	2	123
Wind	2	17	121	3	123
Stream	2	18	121	4	123
Bubble	2	19	121	5	123
Bird Tweet	2	20	121	0	124
Dog Barking	2	21	121	1	124
Horse Gallop	2	22	121	2	124
Bird Tweet 2	2	23	121	3	124
Telephone	2	24	121	0	125
Telephone 2	2	25	121	1	125
Door Creak	2	26	121	2	125
Door Slam	2	27	121	3	125
Scratch	2	28	121	4	125
Wind Chime	2	29	121	5	125
Helicopter	2	30	121	0	126
Car Engine	2	31	121	1	126
Car Stopping	2	32	121	2	126
Car Passing	2	33	121	3	126
Car Crash	2	34	121	4	126
Siren	2	35	121	5	126
Train	2	36	121	6	126
Jet Plane	2	37	121	7	126
Starship	2	38	121	8	126
Burst Noise	2	39	121	9	126
Applause	2	40	121	0	127
Laughing	2	41	121	1	127
Screaming	2	42	121	2	127
Punch	2	43	121	3	127
Heartbeat	2	44	121	4	127
Foot Step	2	45	121	5	127
Gunshot	2	46	121	0	128
Machine Gun	2	47	121	1	128
Laser Gun	2	48	121	2	128

Multi-Timbral mode					
Sound	Off, On 1		On 2		
	Bank LSB	Prog #	Bank MSB	Bank LSB	Prog #
Explosion	2	49	121	3	128
Standard Set	2	50	120	0	1
Room Set	2	51	120	0	9
Power Set	2	52	120	0	17
Electronic Set	2	53	120	0	25
Analog Set	2	54	120	0	26
Jazz Set	2	55	120	0	33
Brush Set	2	56	120	0	41
Orchestra Set	2	57	120	0	49
SFX Set	2	58	120	0	57

DRUM SOUND MAPPING

	Standard Set	Room Set	Power Set	Electronic Set	Analog Set
	D# High Q	High Q	High Q	High Q	High Q
	E Slap	Slap	Slap	Slap	Slap
	F Scratch Push	Scratch Push	Scratch Push	Scratch Push	Scratch Push
	F# Scratch Pull	Scratch Pull	Scratch Pull	Scratch Pull	Scratch Pull
	G Sticks	Sticks	Sticks	Sticks	Sticks
	G# Square Click	Square Click	Square Click	Square Click	Square Click
	A Metronome Click	Metronome Click	Metronome Click	Metronome Click	Metronome Click
	A# Metronome Bell	Metronome Bell	Metronome Bell	Metronome Bell	Metronome Bell
	B Acoustic Bass Drum	Acoustic Bass Drum	Acoustic Bass Drum	Acoustic Bass Drum	Acoustic Bass Drum
C2	C Bass Drum 1	Bass Drum 1	Power Kick Drum	Electric Bass Drum	Analog Bass Drum
	C# Side Stick	Side Stick	Side Stick	Side Stick	Analog Rim Shot
	D Acoustic Snare	Acoustic Snare	Power Snare Drum	Electric Snare 1	Analog Snare 1
	D# Hand Clap	Hand Clap	Hand Clap	Hand Clap	Hand Clap
	E Electric Snare	Electric Snare	Electric Snare	Electric Snare 2	Electric Snare
	F Low Floor Tom	Room Low Tom 2	Power Low Tom 2	Electric Low Tom 2	Analog Low Tom 2
	F# Closed Hi-hat	Closed Hi-hat	Closed Hi-hat	Closed Hi-hat	Analog CHH 1
	G High Floor Tom	Room Low Tom 1	Power Low Tom 1	Electric Low Tom 1	Analog Low Tom 1
	G# Pedal Hi-hat	Pedal Hi-hat	Pedal Hi-hat	Pedal Hi-hat	Analog CHH 2
	A Low Tom	Room Mid Tom 2	Power Mid Tom 2	Electric Mid Tom 2	Analog Mid Tom 2
	A# Open Hi-hat	Open Hi-hat	Open Hi-hat	Open Hi-hat	Analog OHH
	B Low-Mid Tom	Room Mid Tom 1	Power Mid Tom 1	Electric Mid Tom 1	Analog Mid Tom 1
C3	C High-Mid Tom	Room Hi Tom 2	Power Hi Tom 2	Electric Hi Tom 2	Analog Hi Tom 2
	C# Crash Cymbal 1	Crash Cymbal 1	Crash Cymbal 1	Crash Cymbal 1	Analog Cymbal
	D Hi Tom	Room Hi Tom 1	Power Hi Tom 1	Electric Hi Tom 1	Analog Hi Tom 1
	D# Ride Cymbal 1	Ride Cymbal 1	Ride Cymbal 1	Ride Cymbal 1	Ride Cymbal 1
	E Chinese Cymbal	Chinese Cymbal	Chinese Cymbal	Reverse Cymbal	Chinese Cymbal
	F Ride Bell	Ride Bell	Ride Bell	Ride Bell	Ride Bell
	F# Tambourine	Tambourine	Tambourine	Tambourine	Tambourine
	G Splash Cymbal	Splash Cymbal	Splash Cymbal	Splash Cymbal	Splash Cymbal
	G# Cowbell	Cowbell	Cowbell	Cowbell	Analog Cowbell
	A Crash Cymbal 2	Crash Cymbal 2	Crash Cymbal 2	Crash Cymbal 2	Crash Cymbal 2
	A# Vibra-slap	Vibra-slap	Vibra-slap	Vibra-slap	Vibra-slap
	B Ride Cymbal 2	Ride Cymbal 2	Ride Cymbal 2	Ride Cymbal 2	Ride Cymbal 2
C4	C High Bongo	High Bongo	High Bongo	High Bongo	High Bongo
	C# Low Bongo	Low Bongo	Low Bongo	Low Bongo	Low Bongo
	D Mute Hi Conga	Mute Hi Conga	Mute Hi Conga	Mute Hi Conga	Analog Hi Conga
	D# Open Hi Conga	Open Hi Conga	Open Hi Conga	Analog Mid Conga	Analog Mid Conga
	E Low Conga	Low Conga	Low Conga	Analog Low Conga	Analog Low Conga
	F High Timbale	High Timbale	High Timbale	High Timbale	High Timbale
	F# Low Timbale	Low Timbale	Low Timbale	Low Timbale	Low Timbale
	G High Agogo	High Agogo	High Agogo	High Agogo	High Agogo
	G# Low Agogo	Low Agogo	Low Agogo	Low Agogo	Low Agogo
	A Cabasa	Cabasa	Cabasa	Cabasa	Cabasa
	A# Maracas	Maracas	Maracas	Maracas	Analog Maracas
	B Short Whistle	Short Whistle	Short Whistle	Short Whistle	Short Whistle
C5	C Long Whistle	Long Whistle	Long Whistle	Long Whistle	Long Whistle
	C# Short Guiro	Short Guiro	Short Guiro	Short Guiro	Short Guiro
	D Long Guiro	Long Guiro	Long Guiro	Long Guiro	Long Guiro
	D# Claves	Claves	Claves	Claves	Analog Claves
	E Hi Wood Block	Hi Wood Block	Hi Wood Block	Hi Wood Block	Hi Wood Block
	F Low Wood Block	Low Wood Block	Low Wood Block	Low Wood Block	Low Wood Block
	F# Mute Cuica	Mute Cuica	Mute Cuica	Mute Cuica	Mute Cuica
	G Open Cuica	Open Cuica	Open Cuica	Open Cuica	Open Cuica
	G# Mute Triangle	Mute Triangle	Mute Triangle	Mute Triangle	Mute Triangle
	A Open Triangle	Open Triangle	Open Triangle	Open Triangle	Open Triangle
	A# Shaker	Shaker	Shaker	Shaker	Shaker
	B Jingle Bell	Jingle Bell	Jingle Bell	Jingle Bell	Jingle Bell
C6	C Bell Tree	Bar Chimes	Bar Chimes	Bar Chimes	Bar Chimes
	C# Castanets	Castanets	Castanets	Castanets	Castanets
	D Mute Surdo	Mute Surdo	Mute Surdo	Mute Surdo	Mute Surdo
	D# Open Surdo	Open Surdo	Open Surdo	Open Surdo	Open Surdo
	E				

	Jazz Set	Brush Set	Orchestra Set	SFX Set
	D# High Q	High Q	Closed Hi-hat 2	
	E Slap	Slap	Pedal Hi-hat	
	F Scratch Push	Scratch Push	Open Hi-hat 2	
	F# Scratch Pull	Scratch Pull	Ride Cymbal 1	
	G Sticks	Sticks	Sticks	
	G# Square Click	Square Click	Square Click	
	A Metronome Click	Metronome Click	Metronome Click	
	A# Metronome Bell	Metronome Bell	Metronome Bell	
	B Jazz Kick 2	Jazz Kick 2	Concert BD 2	
C2	C Jazz Kick 1	Jazz Kick 1	Concert BD 1	
	C# Side Stick	Side Stick	Side Stick	
	D Acoustic Snare	Brush Tap	Concert SD	
	D# Hand Clap	Brush Slap	Castanets	High Q
	E Electric Snare	Brush Swirl	Concert SD	Slap
	F Low Floor Tom	Low Floor Tom	Timpani F	Scratch Push
	F# Closed Hi-hat	Closed Hi-hat	Timpani F#	Scratch Pull
	G High Floor Tom	High Floor Tom	Timpani G	Sticks
	G# Pedal Hi-hat	Pedal Hi-hat	Timpani G#	Square Click
	A Low Tom	Low Tom	Timpani A	Metronome Click
	A# Open Hi-hat	Open Hi-hat	Timpani A#	Metronome Bell
	B Low-Mid Tom	Low-Mid Tom	Timpani B	Guitar Fret Noise
C3	C High-Mid Tom	High-Mid Tom	Timpani c	Guitar Cutting Noise Up
	C# Crash Cymbal 1	Crash Cymbal 1	Timpani c#	Guitar Cutting Noise Down
	D Hi Tom	Hi Tom	Timpani d	String Slap of Double Bass
	D# Ride Cymbal 1	Ride Cymbal 1	Timpani d#	Fl. Key Click
	E Chinese Cymbal	Chinese Cymbal	Timpani e	Laughing
	F Ride Bell	Ride Bell	Timpani f	Scream
	F# Tambourine	Tambourine	Tambourine	Punch
	G Splash Cymbal	Splash Cymbal	Splash Cymbal	Heart Beat
	G# Cowbell	Cowbell	Cowbell	Footsteps 1
	A Crash Cymbal 2	Crash Cymbal 2	Concert Cymbal 2	Footsteps 2
	A# Vibra-slap	Vibra-slap	Vibra-slap	Applause
	B Ride Cymbal 2	Ride Cymbal 2	Concert Cymbal 1	Door Creaking
C4	C High Bongo	High Bongo	High Bongo	Door
	C# Low Bongo	Low Bongo	Low Bongo	Scratch
	D Mute Hi Conga	Mute Hi Conga	Mute Hi Conga	Wind Chimes
	D# Open Hi Conga	Open Hi Conga	Open Hi Conga	Car-Engine
	E Low Conga	Low Conga	Low Conga	Car-Stop
	F High Timbale	High Timbale	High Timbale	Car-Pass
	F# Low Timbale	Low Timbale	Low Timbale	Car-Crash
	G High Agogo	High Agogo	High Agogo	Siren
	G# Low Agogo	Low Agogo	Low Agogo	Train
	A Cabasa	Cabasa	Cabasa	Jetplane
	A# Maracas	Maracas	Maracas	Helicopter
	B Short Whistle	Short Whistle	Short Whistle	Starship
C5	C Long Whistle	Long Whistle	Long Whistle	Gun Shot
	C# Short Guiro	Short Guiro	Short Guiro	Machine Gun
	D Long Guiro	Long Guiro	Long Guiro	Lasergun
	D# Claves	Claves	Claves	Explosion
	E Hi Wood Block	Hi Wood Block	Hi Wood Block	Dog
	F Low Wood Block	Low Wood Block	Low Wood Block	Horse-Gallop
	F# Mute Cuica	Mute Cuica	Mute Cuica	Birds
	G Open Cuica	Open Cuica	Open Cuica	Rain
	G# Mute Triangle	Mute Triangle	Mute Triangle	Thunder
	A Open Triangle	Open Triangle	Open Triangle	Wind
	A# Shaker	Shaker	Shaker	Seashore
	B Jingle Bell	Jingle Bell	Jingle Bell	Stream
C6	C Bell Tree	Bar Chimes	Bar Chimes	Bubble
	C# Castanets	Castanets	Castanets	
	D Mute Surdo	Mute Surdo	Mute Surdo	
	D# Open Surdo	Open Surdo	Open Surdo	
	E		Applause	

RHYTHM STYLE LIST

- | | | | | | | | |
|----|--------------|----|----------------|----|------------------|-----|-------------------|
| 1 | 8 Beat 1 | 26 | Rim Beat | 51 | Hip Hop 3 | 76 | Jazz Waltz 1 |
| 2 | 8 Beat 2 | 27 | Slow Jam | 52 | Hip Hop 4 | 77 | Jazz Waltz 2 |
| 3 | 8 Beat 3 | 28 | Pop 1 | 53 | Techno 1 | 78 | 5/4 Swing |
| 4 | 16 Beat 1 | 29 | Pop 2 | 54 | Techno 2 | 79 | Tom Swing |
| 5 | 16 Beat 2 | 30 | Electro Pop 1 | 55 | Techno 3 | 80 | Fast 4 Beat |
| 6 | 16 Beat 3 | 31 | Electro Pop 2 | 56 | Heavy Techno | 81 | H.H. Bossa Nova |
| 7 | 16 Beat 4 | 32 | Ride Beat 1 | 57 | 8 Shuffle 1 | 82 | Ride Bossa Nova |
| 8 | 16 Beat 5 | 33 | Ride Beat 2 | 58 | 8 Shuffle 2 | 83 | Beguine |
| 9 | 16 Beat 6 | 34 | Ride Beat 3 | 59 | 8 Shuffle 3 | 84 | Mambo |
| 10 | Rock Beat 1 | 35 | Ride Beat 4 | 60 | Boogie | 85 | Cha Cha |
| 11 | Rock Beat 2 | 36 | Slip Beat | 61 | 16 Shuffle 1 | 86 | Samba |
| 12 | Rock Beat 3 | 37 | Jazz Rock | 62 | 16 Shuffle 2 | 87 | Light Samba |
| 13 | Hard Rock | 38 | Funky Beat 1 | 63 | 16 Shuffle 3 | 88 | Surdo Samba |
| 14 | Heavy Beat | 39 | Funky Beat 2 | 64 | T Shuffle | 89 | Latin Groove |
| 15 | Surf Rock | 40 | Funky Beat 3 | 65 | Triplet 1 | 90 | Afro Cuban |
| 16 | 2nd Line | 41 | Funk 1 | 66 | Triplet 2 | 91 | Songo |
| 17 | 50 Ways | 42 | Funk 2 | 67 | Triplet 3 | 92 | Bembe |
| 18 | Ballad 1 | 43 | Funk 3 | 68 | Triplet 4 | 93 | African Bembe |
| 19 | Ballad 2 | 44 | Funk Shuffle 1 | 69 | Triplet Ballad 1 | 94 | Merenge |
| 20 | Ballad 3 | 45 | Funk Shuffle 2 | 70 | Triplet Ballad 2 | 95 | Reggae |
| 21 | Ballad 4 | 46 | Buzz Beat | 71 | Triplet Ballad 3 | 96 | Tango |
| 22 | Ballad 5 | 47 | Disco 1 | 72 | Motown 1 | 97 | Habanera |
| 23 | Light Ride 1 | 48 | Disco 2 | 73 | Motown 2 | 98 | Waltz |
| 24 | Light Ride 2 | 49 | Hip Hop 1 | 74 | Ride Swing | 99 | Ragtime |
| 25 | Smooth Beat | 50 | Hip Hop 2 | 75 | H.H. Swing | 100 | Country & Western |

LESSON SONG LIST

BURGMÜLLER 25

(25 ETUDES FACILES, OPUS 100)

- | | |
|------------------------|-----|
| 1. La candeur | A0 |
| 2. Arabesque | A#0 |
| 3. Pastorale | B0 |
| 4. Petite réunion | C1 |
| 5. Innocence | C#1 |
| 6. Progrès | D1 |
| 7. Courant Limpide | D#1 |
| 8. La gracieuse | E1 |
| 9. La chasse | F1 |
| 10. Tendre fleur | F#1 |
| 11. La bergeronnette | G1 |
| 12. Adieu | G#1 |
| 13. Consolation | A1 |
| 14. La styrienne | A#1 |
| 15. Ballade | B1 |
| 16. Douce plainte | C2 |
| 17. Babillarde | C#2 |
| 18. Inquiétude | D2 |
| 19. Ave Maria | D#2 |
| 20. Tarentelle | E2 |
| 21. Harmonie des anges | F2 |
| 22. Barcarolle | F#2 |
| 23. Retour | G2 |
| 24. L'hirondelle | G#2 |
| 25. La chevaleresque | A2 |

CZERNY 30

(ETUDES DE MÉCANISME, OPUS 84)

- | | |
|-----------|-----|
| 1. No.1 | A0 |
| 2. No.2 | A#0 |
| 3. No.3 | B0 |
| 4. No.4 | C1 |
| 5. No.5 | C#1 |
| 6. No.6 | D1 |
| 7. No.7 | D#1 |
| 8. No.8 | E1 |
| 9. No.9 | F1 |
| 10. No.10 | F#1 |
| 11. No.11 | G1 |
| 12. No.12 | G#1 |
| 13. No.13 | A1 |
| 14. No.14 | A#1 |
| 15. No.15 | B1 |
| 16. No.16 | C2 |
| 17. No.17 | C#2 |
| 18. No.18 | D2 |
| 19. No.19 | D#2 |
| 20. No.20 | E2 |
| 21. No.21 | F2 |
| 22. No.22 | F#2 |
| 23. No.23 | G2 |
| 24. No.24 | G#2 |
| 25. No.25 | A2 |
| 26. No.26 | A#2 |
| 27. No.27 | B2 |
| 28. No.28 | C3 |
| 29. No.29 | C#3 |
| 30. No.30 | D3 |

**CZERNY 100
(HUNDERT ÜBUNGSSTÜCKE, OPUS 139)**

1. No.1	A0	43. No.43	D#4	85. No.85	G3
2. No.2	A#0	44. No.44	E4	86. No.86	G#3
3. No.3	B0	45. No.45	F4	87. No.87	A3
4. No.4	C1	46. No.46	F#4	88. No.88	A#3
5. No.5	C#1	47. No.47	G4	89. No.89	B3
6. No.6	D1	48. No.48	G#4	90. No.90	C4
7. No.7	D#1	49. No.49	A4	91. No.91	C#4
8. No.8	E1	50. No.50	A#4	92. No.92	D4
9. No.9	F1	51. No.51	A0	93. No.93	D#4
10. No.10	F#1	52. No.52	A#0	94. No.94	E4
11. No.11	G1	53. No.53	B0	95. No.95	F4
12. No.12	G#1	54. No.54	C1	96. No.96	F#4
13. No.13	A1	55. No.55	C#1	97. No.97	G4
14. No.14	A#1	56. No.56	D1	98. No.98	G#4
15. No.15	B1	57. No.57	D#1	99. No.99	A4
16. No.16	C2	58. No.58	E1	100. No.100	A#4
17. No.17	C#2	59. No.59	F1		
18. No.18	D2	60. No.60	F#1		
19. No.19	D#2	61. No.61	G1		
20. No.20	E2	62. No.62	G#1		
21. No.21	F2	63. No.63	A1		
22. No.22	F#2	64. No.64	A#1		
23. No.23	G2	65. No.65	B1		
24. No.24	G#2	66. No.66	C2		
25. No.25	A2	67. No.67	C#2		
26. No.26	A#2	68. No.68	D2		
27. No.27	B2	69. No.69	D#2		
28. No.28	C3	70. No.70	E2		
29. No.29	C#3	71. No.71	F2		
30. No.30	D3	72. No.72	F#2		
31. No.31	D#3	73. No.73	G2		
32. No.32	E3	74. No.74	G#2		
33. No.33	F3	75. No.75	A2		
34. No.34	F#3	76. No.76	A#2		
35. No.35	G3	77. No.77	B2		
36. No.36	G#3	78. No.78	C3		
37. No.37	A3	79. No.79	C#3		
38. No.38	A#3	80. No.80	D3		
39. No.39	B3	81. No.81	D#3		
40. No.40	C4	82. No.82	E3		
41. No.41	C#4	83. No.83	F3		
42. No.42	D4	84. No.84	F#3		

BEYER**(VORSCHULE IM KLAVIERSPIEL, OPUS 101)**

1. No.1	A0	43. No.43	D#4	85. No.85	G3
2. No.2	A#0	44. No.44	E4	86. No.86	G#3
3. No.3	B0	45. No.45	F4	87. No.87	A3
4. No.4	C1	46. No.46	F#4	88. No.88	A#3
5. No.5	C#1	47. No.47	G4	89. No.89	B3
6. No.6	D1	48. No.48	G#4	90. No.90	C4
7. No.7	D#1	49. No.49	A4	91. No.91	C#4
8. No.8	E1	50. No.50	A#4	92. No.92	D4
9. No.9	F1	51. No.51	A0	93. No.93	D#4
10. No.10	F#1	52. No.52	A#0	94. No.94	E4
11. No.11	G1	53. No.53	B0	95. No.95	F4
12. No.12	G#1	54. No.54	C1	96. No.96	F#4
13. No.13	A1	55. No.55	C#1	97. No.97	G4
14. No.14	A#1	56. No.56	D1	98. No.98	G#4
15. No.15	B1	57. No.57	D#1	99. No.99	A4
16. No.16	C2	58. No.58	E1	100. No.100	A#4
17. No.17	C#2	59. No.59	F1	101. No.101	A0
18. No.18	D2	60. No.60	F#1	102. No.102	A#0
19. No.19	D#2	61. No.61	G1	103. No.103	B0
20. No.20	E2	62. No.62	G#1	104. No.104	C1
21. No.21	F2	63. No.63	A1	105. No.105	C#1
22. No.22	F#2	64. No.64	A#1	106. No.106	D1
23. No.23	G2	65. No.65	B1		
24. No.24	G#2	66. No.66	C2		
25. No.25	A2	67. No.67	C#2		
26. No.26	A#2	68. No.68	D2		
27. No.27	B2	69. No.69	D#2		
28. No.28	C3	70. No.70	E2		
29. No.29	C#3	71. No.71	F2		
30. No.30	D3	72. No.72	F#2		
31. No.31	D#3	73. No.73	G2		
32. No.32	E3	74. No.74	G#2		
33. No.33	F3	75. No.75	A2		
34. No.34	F#3	76. No.76	A#2		
35. No.35	G3	77. No.77	B2		
36. No.36	G#3	78. No.78	C3		
37. No.37	A3	79. No.79	C#3		
38. No.38	A#3	80. No.80	D3		
39. No.39	B3	81. No.81	D#3		
40. No.40	C4	82. No.82	E3		
41. No.41	C#4	83. No.83	F3		
42. No.42	D4	84. No.84	F#3		

CLASSICAL PIANO COLLECTION SONG LIST

Tambourin	J.P. Rameu
The harmonious blacksmith	G.F. Händel
Menuette BWV. Anh.114	J.S. Bach
Menuette BWV. Anh.115	J.S. Bach
Menuette BWV. Anh.116	J.S. Bach
Le Coucou	J.S. Bach
Gavotte	F.J. Gossec
Menuette	L. Boccherini
Thema und Variationen <Sonate für Klavier No.11 K.331(300i)>	W.A. Mozart
Türkischer Marsch <Sonate für Klavier No.11 K.331(300i)>	W.A. Mozart
Menuette	W.A. Mozart
Sonate für Klavier No.14 "Mondschein"	L.v. Beethoven
Sonate für Klavier No.8 "Pathétique"	L.v. Beethoven
Für Elise	L.v. Beethoven
Rondo favori	J.N. Hummel
Impromptu op.90-4	F.P. Schubert
Moments musicaux op.94-3	F.P. Schubert
Entr' acte	F.P. Schubert
Impromptu op.142-3	F.P. Schubert
Auf Flügeln des Gesanges	F. Mendelssohn

Frühlingslied	F. Mendelssohn
Rondo Capriccioso	F. Mendelssohn
Chanson de l'adieu	F.F. Chopin
Raindrop	F.F. Chopin
Petit chien	F.F. Chopin
Nocturne No.2	F.F. Chopin
Fantaisie-Impromptu	F.F. Chopin
Polonaise No.3 "Militaire"	F.F. Chopin
Polonaise No.6 "Héroïque"	F.F. Chopin

SOUND DEMO SONG LIST

Piano 1	Concert Grand Studio Grand Mellow Grand	Valse, op.64-1 / Chopin Original La Fille aux Cheveux de Lin / Debussy
Piano 2	Modern Piano Rock Piano New Age Piano	Original Original Original
Electric Piano	Classic E.Piano Modern E.P. Modern E.P. 2	Original Original Original
Drawbar	Jazz Organ Drawbar Organ Drawbar Organ 2	Original Original Original
Church Organ	Church Organ Diapason Full Ensemble	Toccata / Eugene Gigout Wohl mir, daß ich Jesum habe / Bach Original
Harpsi & Mallets	Harpsichord Vibraphone Clavi Harpsichord Oct.	French Suite No.6 / Bach Original Original Prelude in A ^b / Bach
Strings	Slow Strings String Pad String Ensemble	Original Original Le quattro stagioni la primavera / Vivaldi
Choir & Pad	Choir New Age Pad Atmosphere	Original Original Original
Bass	Wood Bass Electric Bass W. Bass & Ride	Original Original Original
Others		Zwei Rapsodien Op.79 Nr.2 / J. Brahms Piano Concerto a moll Op.16 / E. Grieg

CONCERT MAGIC SONG LIST

Title	Note#	Type		
			My Bonnie Lies Over The Ocean	E3 EB
			Oh Susanna	D#4 SK
			On Top Of Old Smokey	E4 EB
			Take Me Out To The Ballgame	C4 EB
			The Band Played On	G4 EB
			When Johnny Comes Marching Home	G#4 MP
			When The Saints Go Marching In	A4 EB
CHILDREN'S SONGS				
Bingo	G#1	EB		
Frère Jacques	F#1	MP		
Good Morning To You	F1	MP		
Hickory Dickory Dock	D#1	EB		
I'm A Little Teapot	A#0	MP		
Itsy, Bitsy Spider	A1	MP		
London Bridges	C#1	MP		
Mary Had A Little Lamb	C1	MP		
Pop Goes The Weasel	E1	MP		
Row, Row, Row Your Boat	D1	MP		
The Farmer In The Dell	G1	MP		
This Old Man	B0	MP		
Twinkle, Twinkle, Little Star	A0	MP		
CHRISTMAS SONGS				
Deck The Halls	C2	MP		
Hark The Herald Angels Sing	A#1	MP		
Jingle Bells	B1	MP		
Joy To The World	D2	MP		
O Come All Ye Faithful	C#2	MP		
Silent Night	E2	MP		
The First Noel	D#2	MP		
We Wish You A Merry Christmas	F2	MP		
What Child Is This? (Greensleeves)	F#2	MP		
PATORIOTIC SONGS				
America The Beautiful	A2	MP		
Battle Hymn Of The Republic	G#2	MP		
Hail To The Chief	B2	MP		
My Country 'Tis Of Thee	G2	MP		
Yankee Doodle	A#2	MP		
AMERICAN CLASSICS				
Auld Lang Syne	C#4	MP		
Beautiful Dreamer	A#4	EB		
Bicycle Built For Two	F4	EB		
Bill Bailey Won't You Please Come Home	G3	EB		
Camptown Races	F#4	MP		
Clementine	A3	MP		
Danny Boy	C3	EB		
Down In The Valley	C#3	EB		
Fascination	A#3	SK		
For He's A Jolly Good Fellow	F#3	EB		
Give My Regards To Broadway	G#3	SK		
Home On The Range	B3	MP		
Home Sweet Home	D#3	EB		
In The Good Old Summertime	F3	EB		
Let Me Call You Sweetheart	D3	EB		
Michael Row The Boat Ashore	D4	MP		
			FAVORITE HYMNS	
			A Mighty Fortress	D6 MP
			Amazing Grace	C5 MP
			Doxology	C#5 MP
			Fairest Lord Jesus	B4 MP
			For The Beauty Of The Earth	D5 MP
			Gloria Patri	C#6 MP
			Holy, Holy, Holy	F5 MP
			It Is Well With My Soul	C6 MP
			Jesus Loves The Little Children	B5 MP
			Just As I Am	A#5 MP
			O Worship The King	D#5 MP
			Rock Of Ages	G5 MP
			Sweet Hour Of Prayer	A5 MP
			The Old Rugged Cross	E5 MP
			Trust And Obey	G#5 MP
			What A Friend We Have In Jesus	F#5 MP
			CLASSICAL SELECTIONS	
			An Die Freude (Ode To Joy)	F6 MP
			Andante (Haydn)	D#6 MP
			Blue Danube Waltz	B6 SK
			Clair De Lune	F#6 SK
			Fledermaus	E7 EB
			Für Elise	E6 EB
			Gavotte (Gossec)	C#7 SK
			Minuet In G (Bach)	A6 SK
			Peter And The Wolf	G#6 SK
			Romeo And Juliet	A#6 SK
			Skater's Waltz	G6 SK
			Sleeping Beauty Waltz	C7 EB
			Toreador Song ("Carmen")	D#7 SK
			Waltz Of The Flowers	D7 SK
			SPECIAL OCCASIONS	
			Bridal Chorus	F7 MP
			Wedding March	F#7 SK
			INTERNATIONAL SONGS	
			Chiapenacas	C8 SK
			Funiculi Funicula	A#7 SK
			Hatikvah	G#7 MP
			La Marseillaise	B7 MP
			My Wild Irish Rose	A7 EB
			When Irish Eyes Are Smiling	G7 EB

Front Panel

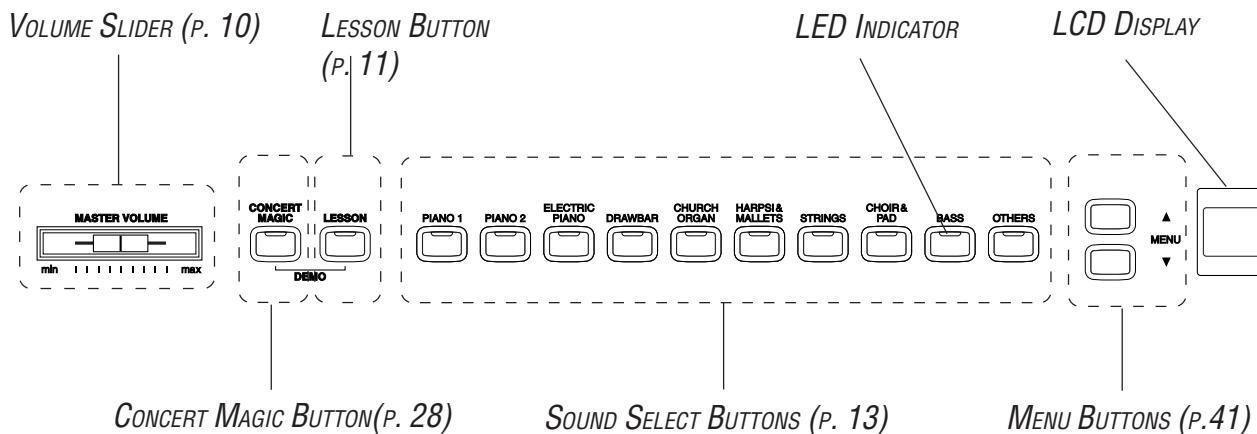

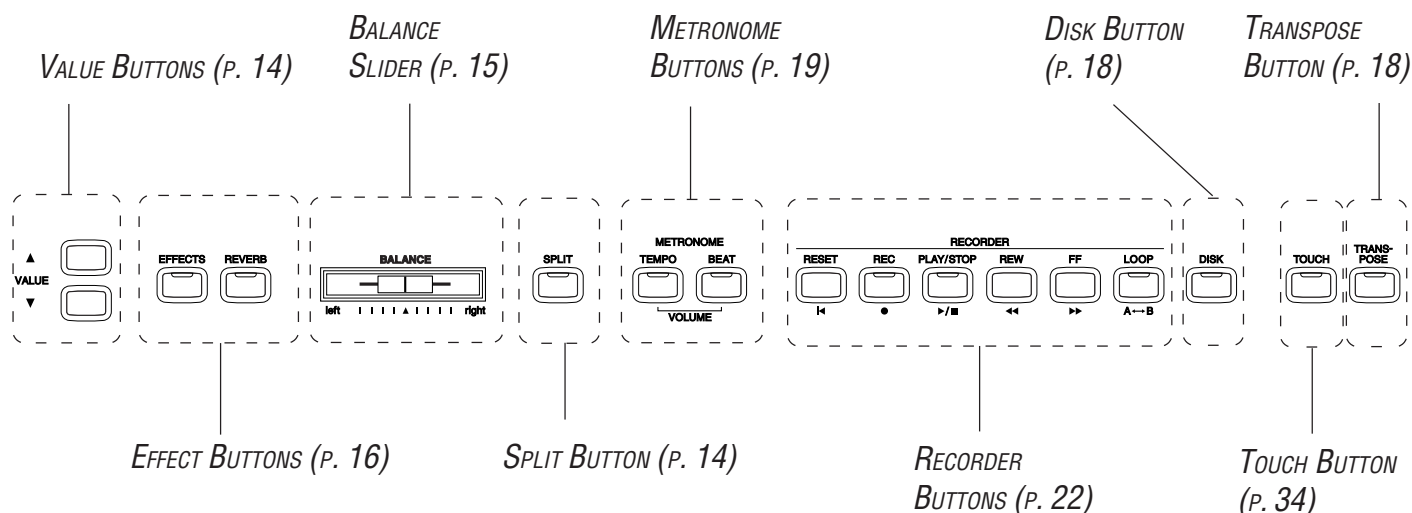

Specifications

	CN4
Keyboard	88 Weighted Keyboard with Advanced Hammer Action IV
Polyphony	Maximum 96
Number of Sound	305 + 9 Drum Sets
Sound Categories	Piano 1, Piano 2, Electric Piano, Drawbar, Church Organ, Harpsi&Mallets, Strings, Choir&Pad, Bass, Others
Effects	Reverb (6), Chorus (5), Flanger, Tremolo, Delay (3), Rotary (2)
Temperaments	Equal (Piano Only), Mersenne pure (Major), Mersenne pure (minor), Pythagorea, Meantone, Werckmeister III, Kirnberger III, Equal (flat), Equal
Internal Recorder	3 Songs, 2 Tracks The total memory capacity of the recorder is approximately 90,000 notes.
Disk Recorder	16 Tracks, Realtime Recording
Other Features	Concert Magic (88 Preset Songs), Volume, Dual, Split, Balance Slider, Lesson Function, Metronome, Transpose, Tune, Lower Octave Shift, Lower Pedal On/Off, Touch Curve (Light, Light+, Normal, Heavy, Heavy+, Off), MIDI (16 part multi-timbral capability)
Pedals	Sustain, Sostenuto, Soft
Jacks	Headphones (2), LINE IN (L/MONO, R), LINE OUT (L/MONO, R), MIDI (IN, OUT, THRU), USB
Output Power	40 W x 2
Speakers	16 cm x 2
Power Consumption	80 W
Finish	Rosewood, Mahogany, European Cherry
Dimensions (WxDxH) (without Music Rack)	1405 x 469 x 858 mm 55" x 19" x 34"
Weight (without bench)	50 kg, 110 LB's

MIDI EXCLUSIVE DATA FORMAT



- 1 F0..... Start code
- 2 40..... Kawai's ID number
- 3 00 - 0F MIDI channel
- 4 10, 30..... Function code (30 when setting MULTI TIMBRE ON/OFF)
- 5 04..... Indicates that the instrument is Electronic Piano
- 6 08..... Indicates that the piano is "CN4"
- 7 data 1
- 8 data 2..... (See the table below.)
- 9 data 3
- 10 F7..... End code

data 1	data 2	data 3	Function
00	00	—	Multi Timbre Off
00	01	—	Multi Timbre On 1
00	02	—	Multi Timbre On 2
0D	00–0C	—	00: Effect Off, 01: Chorus 3, 02: Delay 1, 03: Delay 2, 04: Delay 3, 05: Tremolo, 06: Rotary 1, 07: Rotary 2, 08: Chorus 1, 09: Chorus 2 0a: Chorus 4, 0b: FB Chorus, 0c: Flanger
0E	00–03, 06–08	—	00: Reverb Off, 01: Room 2, 02: Stage, 03: Hall 1, 06: Room 1, 07: Hall 2, 08: Plate
14	00–7F	—	Dual/Split balance
16	1F–60	—	Tune, 40: 440 Hz
17	00, 7F	—	00: Program Change Off, 7F: Program Change On
18	00–07	—	00: Light, 01: Normal, 02: Heavy, 03: Off, 04: Light+, 05: Heavy+, 06: User 1, 07: User 2
19	00–03	—	Lower Octave Shift
20	00–7F	00–7F	Dual Program Change, data 2: Right sound, data 3: Left sound
21	00–7F	00–7F	Split Program Change, data 2: Upper sound, data 3: Lower sound
25	00–08	00–0B	data 2: Temperament, data 3: Key
26	00, 7F	00–0F	Multi Timbre, data 2: 00 (On), 7F (Off), data 3: channel
27	00–02	00–02	Dual/Split, Right (Upper)/Left (Lower), sound Bank LSB

MIDI IMPLEMENTATION CHART

DATE: MARCH 2005

KAWAI DIGITAL PIANO MODEL: CN4

VERSION 1.0

Function		Transmit	Receive	Remarks
Basic Channel	Default	1	1-16	
	Changes	1-16	1-16	
Mode	Default	3	3	
	Messages Altered	X *****	3, 4	
Note Number	True voice	21-108* *****	0-127 0-127	*9-120 w/Transpose
Velocity	Note ON	○ 9nH v=1-127	○	
	Note OFF	X 9nH v=0	X	
After Touch	Key's	X	X	
	Ch's	X	○	
Pitch Bend		X	○	
Control Change	0, 32	○	○	Bank Select
	1	X	○	Modulation
	5	X	○	Portament Time
	6, 38	X	○	Data Entry
	7	○	○	Volume
	10	X	○	Panpot
	11	X	○	Expression Pedal
	64	○ (Right pedal)	○	Sustain Pedal
	65	X	○	Portament
	66	○ (Center pedal)	○	Sostenuto Pedal
	67	○ (Left pedal)	○	Soft Pedal
	69	○	○	Hold 2
	70	X	○	Sustain Level
	71	X	○	Resonance
	72	X	○	Release Time
	73	X	○	Attack Time
	74	X	○	Cutoff
	75	X	○	Decay Time
	76	X	○	Vibrato Speed
	77	X	○	Vibrato Depth
	78	X	○	Vibrato Delay
	84	X	○	Portament Control
	91	○	○	Reverb Send Level
93	○	○	Chorus Send Level	
98, 99	X	○	NRPN LSB, MSB	
100, 101	X	○	RPN LSB, MSB	
Program Change	: True #	○ 0-127 *****	○	
System Exclusive		○	○	
Common	: Song Position	X	X	
	: Song Select	X	X	
	: Tune	X	X	
System Real Time	: Clock	○	○	
	: Commands	○ FA, FB, FC	○	
Aux	: All Sound Off	X	○ (120)	
	: Reset All Controller	X	○ (121)	
	: Local On/Off	X	X	
	: All Note Off	X	○ (123-127)	
	: Active Sense	○	○	
	: Reset	X	X	
Notes				

Mode 1: OMNI ON, POLY

Mode 2: OMNI ON, MONO

○: Yes

Mode 3: OMNI OFF, POLY

Mode 4: OMNI OFF, MONO

X: No

KAWAI