

**KAWAI
DIGITAL PIANO**

CN270

OWNER'S MANUAL

Thank you for choosing this Kawai CN270 Digital Piano.
 Your new CN270 is a high-quality instrument offering the very latest in leading-edge music technology.
 This manual contains valuable information that will help you make full use of your CN piano's many capabilities. Please read it carefully and keep it handy for further reference.

TABLE OF CONTENTS

	Page
Important Safety Instructions	3
Assembling The Stand	6
Part Names	8
Getting Started	
1. Basic Operations	10
2. Transpose	11
3. Touch Response	11
4. Demonstration Songs	11
Digital Recording Functions	
1. Easy Recording	12
2. Playing Back A Song	12
3. Advanced Recording/Playback Functions	13
4. Deleting A Song/Track	15
Programming Mode	
1. Selecting A Touch Type	16
2. Tuning	17
3. MIDI Channel Select	17
4. Transmit MIDI Program Change On/Off	18
5. Multi-Timbral Mode On/Off	18
6. MIDI Local Control On/Off	19
7. Reset	19
MIDI	20
SPECIFICATIONS	22
MIDI IMPLEMENTATION CHART	23

Important Safety Instructions

SAVE THESE INSTRUCTIONS

INSTRUCTIONS PERTAINING TO A RISK OF FIRE, ELECTRIC SHOCK, OR INJURY TO PERSONS



WARNING

TO REDUCE THE RISK OF FIRE OR ELECTRIC SHOCK, DO NOT EXPOSE THIS PRODUCT TO RAIN OR MOISTURE.

AVIS : RISQUE DE CHOC ELECTRIQUE - NE PAS OUVRIR.

TO REDUCE THE RISK OF ELECTRIC SHOCK, DO NOT REMOVE COVER (OR BACK). NO USER-SERVICEABLE PARTS INSIDE. REFER SERVICING TO QUALIFIED SERVICE PERSONNEL.



The lightning flash with arrowhead symbol, within an equilateral triangle, is intended to alert the user to the presence of uninsulated "dangerous voltage" within the product's enclosure that may be of sufficient magnitude to constitute a risk of electric shock to persons.



The exclamation point within an equilateral triangle is intended to alert the user to the presence of important operating and maintenance (servicing) instructions in the literature accompanying the product.

Examples of Picture Symbols



denotes that care should be taken. The example instructs the user to take care not to allow fingers to be trapped.



denotes a prohibited operation. The example instructs that disassembly of the product is prohibited.



denotes an operation that should be carried out. The example instructs the user to remove the power cord plug from the AC outlet.

Read all the instructions before using the product.

WARNING - When using electric products, basic precautions should always be followed, including the following.



WARNING Indicates a potential hazard that could result in death or serious injury if the product is handled incorrectly.

The product should be connected to an AC outlet of the specified voltage.



- Use the AC adapter supplied with the product or one recommended by Kawai.
- If you are going to use an AC power cord, make sure that its has the correct plug shape and conforms to the specified power voltage.
- Failure to do so may result in fire.

Do not insert or disconnect the power cord plug with wet hands.



Doing so may cause electric shock.

The chair must be used properly (it must be used only when playing the product).

- Do not play with it or stand on it.
- Only one person is allowed to sit on it.
- Do not sit on it during height adjustment.
- Do not sit on it when opening the lid.

Doing so may cause the chair to fall over or your fingers to be trapped, resulting in injury.

When using the headphones, do not listen for long periods of time at high volume levels.

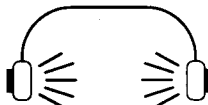

Doing so may result in hearing problems.

Do not lean against the keyboard.

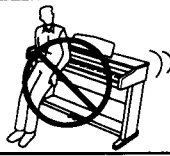

Doing so may cause the product to fall over, resulting in injury.

Do not disassemble, repair or modify the product.



Doing so may result in product breakdown, electric shock or short-circuit.

When disconnecting the AC power cord's plug, always hold the plug and pull it to remove it.



● Pulling the AC power cord itself may damage the cord, causing a fire, electric shock or short-circuit.

If the product will not be used for a long time, unplug the AC power cord from the AC outlet.



● Failure to do so may cause fire in case of lightning.
● Failure to do so may over-heat the product, resulting in fire.

This product may be equipped with a polarized line plug (one blade wider than the other). This is a safety feature. If you are unable to insert the plug into the outlet, contact an electrician to replace your obsolete outlet. Do not defeat the safety purpose of the plug.

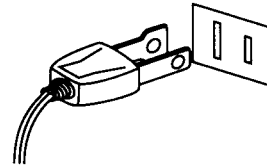

CAUTION

Indicates a potential hazard that could result in injury or damage to the product or other

Do not use the product in the following areas.

- Areas, such as those near windows, where the product is exposed to direct sunlight
- Extremely hot areas, such as near a heater
- Extremely cold areas, such as outside
- Extremely humid areas
- Areas where a large amount of sand or dust is present
- Areas where the product is exposed to excessive vibrations

Using the product in such areas may result in product breakdown.

When you close the keyboard cover, close it gently.

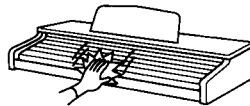

Closing it roughly may trap your fingers, resulting in injury.

Before connecting cords, make sure that the power to this product and other devices is turned OFF.



Failure to do so may cause breakdown of this product and other devices.

Take care not to allow any foreign matter to enter the product.

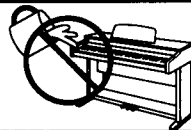

Entry of water, needles or hair pins may result in breakdown or short-circuit.

Do not drag the product on the floor. Take care not to drop the product.

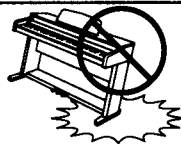

Please lift up the product when moving it. Please note that the product is heavy and must be carried by more than two persons. Dropping the product may result in breakdown.

Do not place the product near electrical appliances such as TVs and radios.

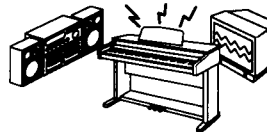

● Doing so may cause the product to generate noise.
● If the product generates noise, move the product sufficiently away from the electrical appliance or connect it to another AC outlet.

When connecting the AC power cord and other cords, take care not to get them tangled.

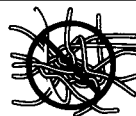

Failure to do so may damage them, resulting in fire, electric shock or short-circuit.

Do not wipe the product with benzene or thinner.



- Doing so may result in discoloration or deformation of the product.
- When cleaning the product, put a soft cloth in lukewarm water, squeeze it well, then wipe the product.

Do not stand on the product or exert excessive force.



- Doing so may cause the product to become deformed or fall over, resulting in breakdown or injury.

The product should be located so that its location or position does not interfere with its proper ventilation.

This product should be used only with the stand that is provided by the manufacturer.

The product should be serviced by qualified service personnel when:

- The power supply cord or the plug has been damaged.
- Objects have fallen, or liquid has been spilled into the product.
- The product has been exposed to rain.
- The product does not appear to operate normally or exhibits a marked change in performance.
- The product has been dropped, or the enclosure damaged.

Notes on Repair

Should an abnormality occur in the product, immediately turn the power OFF, disconnect the power cord plug, and then contact the shop from which the product was purchased.

- **This digital piano is for household use and is not intended for commercial use.**

CAUTION:

To prevent electric shock, match wide blade of plug to wide slot, fully insert.

ATTENTION:

Pour éviter les chocs électriques, introduire la lame la plus large de la fiche dans la borne correspondante de la prise et pousser jusqu'au fond.

Instruction for AC power cord (U.K.)

Do not plug either terminal of the power cord to the ground of the AC outlet on the wall.

FCC Information

This equipment has been tested and found to comply with the limits for a Class B digital device, pursuant to Part 15 of the FCC Rules. These limits are designed to provide reasonable protection against harmful interference in a residential installation. This equipment generates, uses and can radiate radio frequency energy and, if not installed and used in accordance with the instructions, may cause harmful interference to radio communications.

If this equipment does cause harmful interference to radio or television reception, which can be determined by turning the equipment off and on, the user is encouraged to try to correct the interference by one or more of the following measures:

- Reorient or relocate the receiving antenna.
- Increase the separation between the equipment and receiver.
- Connect the equipment into an outlet on a different electrical circuit from the receiver.
- Consult the dealer or an experienced radio/TV technician for help.

Canadian Radio Interference Regulations

This instrument complies with the limits for a class B digital apparatus, pursuant to the Radio Interference Regulations, C.R.C., c. 1374.

ASSEMBLING THE STAND

Be sure that all parts are included before starting to assemble your unit.

PARTS PROVIDED

Side Panel (A)	2 pcs.
Back Panel (B)	1 pc.
Pedal Board (C)	1 pc.
Screw (D)	2 pcs.
Screw (E)	4 pcs.
Bolt (F)	8 pcs.
Adjuster (G)	1 pc.

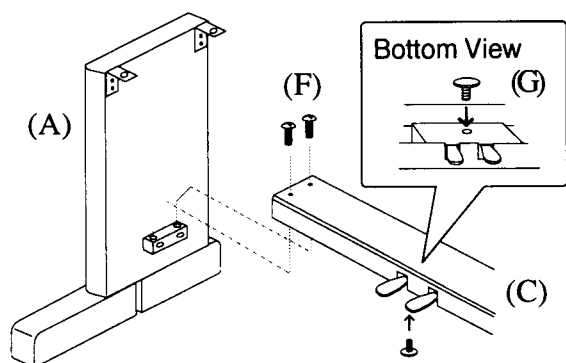
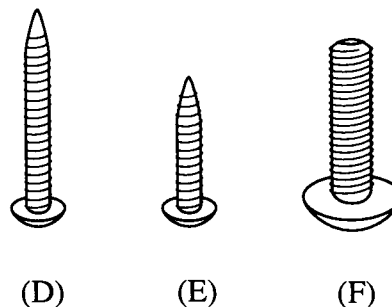

1. Insert the Adjuster (G) on the bottom of Pedal Board (C). Fasten (A) and (C) with four bolts (F).

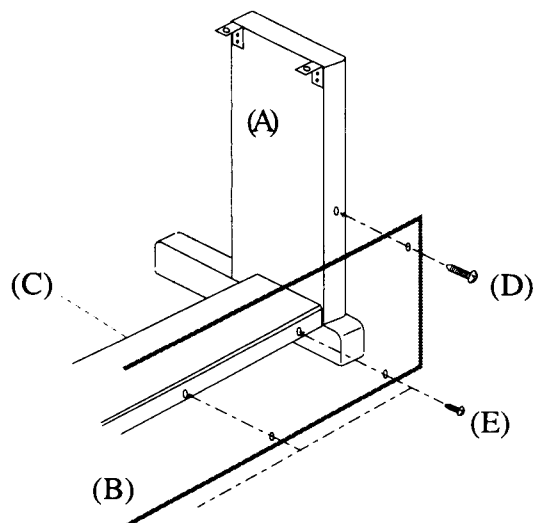

2. Fasten Side Panel (A) and Back Panel (B) with two screws (D). Then fix Back Panel (B) to Pedal Board (C) with four screws (E).

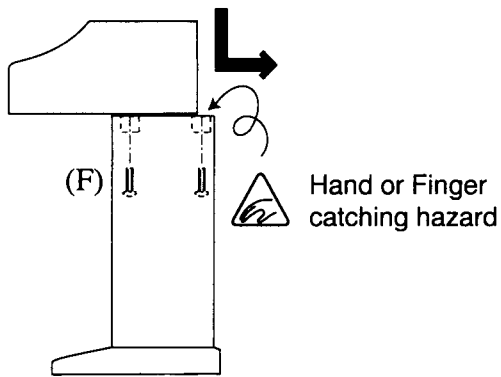

3. Place the piano on the front half of the stand so that the metal fitting holes are seen when viewed from the top. Slide the piano backward while holding it with one hand so that it does not incline and fall from the stand. The hooks on the piano are then engaged with the metal fittings on the Side Panels. Pay attention so that your hand or fingers are not caught between the stand and piano. Fasten the piano and the stand with four bolts(F).

CAUTION: Be sure to secure the piano to the stand with the screws. If you fail to do so, the unit could fall from the stand causing damage or personal injury.

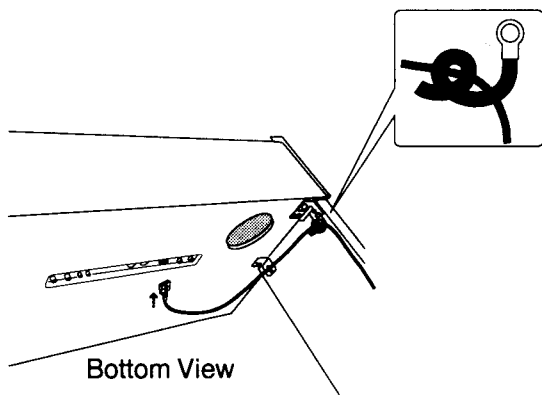

4. Insert the pedal connection cord that comes from Pedal Board (C) into the piano's pedal jack and fasten with clasp.

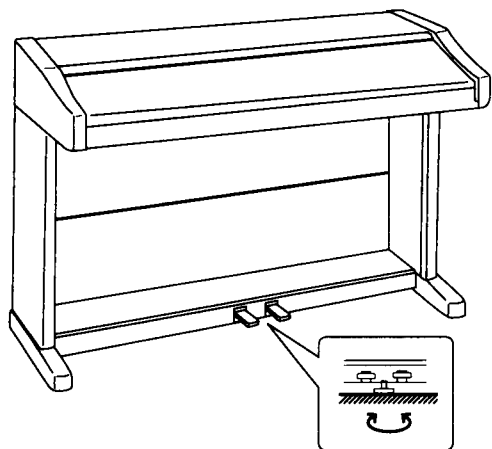

5. Turn the Adjuster (installed on the bottom of C) until it touches the floor to support the pedal board.

PART NAMES

VOLUME SLIDER (A)

Move the volume slider to the right to increase the instrument's volume. Move the slider to the left to decrease the volume.

DEMO BUTTON (B)

To listen to all the demos, simply press this button. The CN piano will start the demo. Eight musical pieces will be played back randomly until the DEMO button is pressed again to stop. To select a specific demo, press the desired TONE button while the demo is playing. To stop the demo, press this button again.

tone button (C)

Select the desired instrument by pressing the appropriate button.

EFFECTS SECTION (D)

These buttons add effects (CHORUS, REVERB) to any sound which enhances the tonal quality and improves the acoustical realism.

RECORDER SECTION (E)

You can record and play back up to three songs.

-PLAY/STOP button: Used to play back and stop a recorded song.

-RECORD button: Used to start recording a song.

FUNCTION SECTION (F)

Use these buttons to select a touch type, transpose the keyboard, or control other features (including MIDI functions).

FRONT PANEL

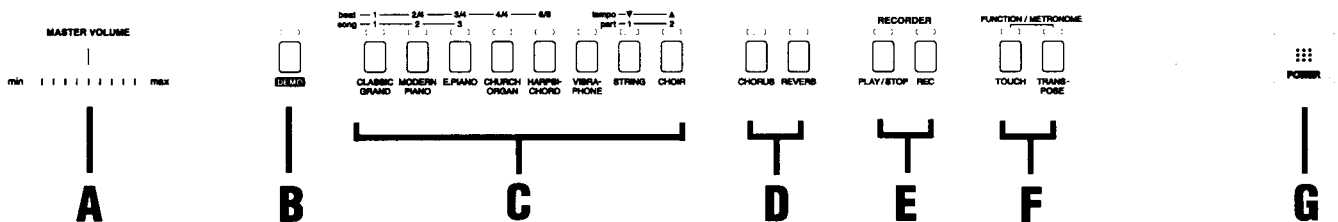

POWER BUTTON (G)

This button turns the instrument on and off. Be sure to turn off the instrument when you are finished playing.

SOFT PEDAL (H)

Pressing this pedal softens the sound and also reduces its volume.

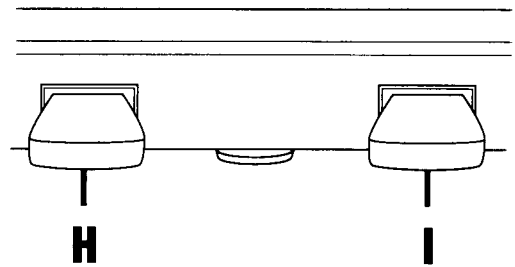

* The soft pedal can be used as the sostenuto pedal by turning on the power while depressing this pedal.

SOSTENUTO PEDAL

Depressing this pedal after pressing the keyboard and before releasing the keys sustains the sound of only the keys just played.

SUSTAIN PEDAL (I)

Pressing this pedal sustains the sound even after you remove your hands from the keyboard.

LINE IN/OUT JACKS (J)

Connect an external amplifier and speakers, or a cassette recorder to these jacks.

MIDI JACKS (K)

Use these jacks to connect the CN piano with external MIDI devices.

PEDAL JACK (L)

Connect the pedal cord from the pedal board to this jack. When you want to use the piano without the stand included, optional F-1 DP Foot Switch which has matching connector to this jack is available.

HEADPHONES JACKS (M)

Used to connect up to two headphones to this digital piano.

BOTTOM

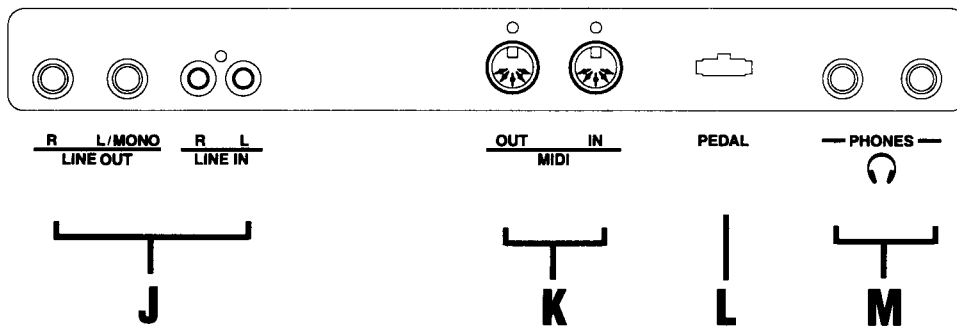

GETTING STARTED

1. BASIC OPERATIONS

(1) Turn on the power.

(2) Adjust the volume.

Play a note on the keyboard and adjust the volume (Moving the slider to the right raises the volume while moving to the left lowers it.)

(3) Choose a tone.

Pressing a TONE button automatically changes the sound made by the CN piano. The LED above the selected tone button will light to indicate which tone is currently in being used.

(4) Play.

Experiment by playing the different tones.

(5) Dual

With DUAL mode you can layer two sounds together. To layer two sound, press the TONE buttons for both sounds simultaneously.

(6) Effect

-REVERB adds reverberation to the sound simulating the acoustic environment of a recital room, stage, or concert hall.

There are three types of Reverb in the CN270. They are Room, Stage and Hall. To change the Reverb type, press one of the following TONE buttons while holding down the REVERB button.

CLASSIC GRAND	Room
MODERN PIANO	Stage
E.PIANO	Hall

The Reverb is “ON” when the LED above the REVERB button is lit. Pressing the REVERB button once again turns the Reverb “OFF”.

When the power is turned on, the REVERB function is automatically activated.

-CHORUS adds a deep richness to any sound.

To turn on the Chorus effect, press the CHORUS button. The LED above the Chorus button will be lit to indicate the Chorus effect is now on.

Pressing the CHORUS button once again turns the Chorus “OFF”.

NOTE:

1. The CN piano can play up to 32 notes simultaneously (32-note polyphonic).
2. When playing in DUAL mode, the CN270 can play up to 16 notes simultaneously (16-note polyphonic).

2. TRANSPOSE

(1) Press the TRANSPOSE button and the LED above it will be lit. The LED above the current key button (TONE button) will also be lit. If the key of “C” is selected the TRANSPOSE button will not light. (When power is first turned “on”, the key is set to C.) When any key other than “C” is selected the TRANSPOSE LED will light.

(2) While holding down the TRANSPOSE button, press the key button (TONE button) for the key you would like to transpose to. To select a key with a “sharp” or “flat”, simultaneously press the buttons on either side of that key. For example, simultaneously pressing the “D” and “E” buttons selects “E-flat”.

(3) To turn off the TRANSPOSE function, press the TRANSPOSE button again. The TRANSPOSE LED will go off and the key of the piano will return to C. Whenever the TRANSPOSE LED is on the CN piano will be transposed to your desired key.

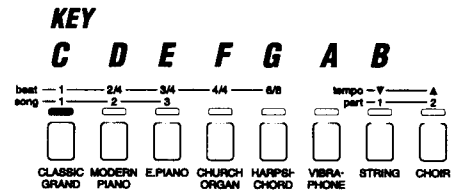

E-flat

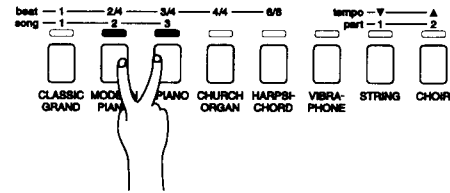

3. TOUCH RESPONSE

When playing a piano, the volume of the sound produced increases in direct relation to how hard a key is struck. The CN piano offers the realistic feel of an acoustic piano for practicing music. The Touch Response function simulates the standard touch of an acoustic piano when the TOUCH LED is off. When the TOUCH LED is lit, you can select other Touch Types. (Refer to the PROGRAMMING MODE section of this manual.)

4. DEMONSTRATION SONG

The CN piano has 8 built in demonstration songs for your listening enjoyment.

(1) **Press the DEMO button** and the demo for CLASSIC GRAND will start. When the CLASSIC GRAND demo is finished the CN piano will play all the other demos one at a time in random order.

(2) If you would like to listen to the demo for a particular sound, just press the desired TONE button while the demo is playing. When you press the TONE button, the demo for that newly selected sound will be played.

(3) To stop the demo, press the DEMO button again at any time.

DIGITAL RECORDING FUNCTIONS

1. EASY RECORDING

(1) Press the REC button. The CN piano will be ready for recording. To cancel the recording, press the REC button again.

(2) Begin playing some music on the piano. The CN piano will automatically start recording with the first note you play. You can also start recording by pressing the PLAY/STOP button.

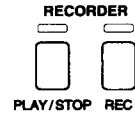

(3) Press the PLAY/STOP button when you have finished recording.

NOTE:

Starting another recording will delete the song you previously recorded. To save your recorded song, record use the “ADVANCED RECORDING/PLAYBACK FUNCTIONS” section.

METRONOME/SELECT TIME AND TEMPO

The CN piano's metronome function can help you record a song by providing a steady beat for you to play along with. The metronome beats however, are not recorded.

(1) To start the metronome, press the TOUCH and TRANSPOSE buttons at the same time. If you want to you can change the beat (time signature) of the metronome. The CN piano has five beats (time signatures) to choose from, 1/4, 2/4, 3/4, 4/4, and 6/8. While holding down the TOUCH and TRANSPOSE buttons, select the desired beat (time signature) of the metronome by pressing the TONE button assigned to that beat (time signature).

(2) To adjust the tempo, press the STRING button while holding down the TOUCH and TRANSPOSE buttons to make the tempo slower or press the CHOIR button while holding down the TOUCH and TRANSPOSE buttons to make the tempo faster.

(3) To turn off the metronome function, press the TOUCH and TRANSPOSE buttons at the same time and the metronome will stop.

2. PLAYING BACK A SONG

(1) Press the PLAY/STOP button. The song will be played back using the same tone (sound) with which it was recorded.

(2) Press the PLAY/STOP button once again to stop the playback. If you do not press the PLAY/STOP button, playback will automatically stop when the song is finished. You can adjust the tempo of playback. Before pressing the PLAY/STOP button, press the STRING button while holding down the TOUCH and TRANSPOSE buttons to make the tempo slower or press the CHOIR button while holding down the TOUCH and TRANSPOSE buttons to make the tempo faster.

3. ADVANCED RECORDING/PLAYBACK FUNCTIONS

RECORDING MORE SONGS

The CN piano can record and store a maximum of 3 songs. Please follow the steps below to save your songs:

- (1) While holding down the REC button, press the MODERN PIANO (Song 2) button. The LED will light to show the current song number (while the REC button is held down). The piano will be ready to record (Song 2). To cancel without recording, press the REC button again.
- (2) Play the piano. Playing the piano will automatically start the recording. You can also start recording by pressing the PLAY/STOP button.
- (3) Press the PLAY/STOP button after you have finished recording.
- (4) Holding down the PLAY/STOP button, press the MODERN PIANO (Song 2) button.
- (5) Releasing both buttons will play Song No.2. Playback will automatically stop when the song is finished. You can adjust the tempo of playback. Before pressing the PLAY/STOP button, press the STRING button while holding down the TOUCH and TRANSPOSE buttons to make the tempo slower or press the CHOIR button while holding down the TOUCH and TRANSPOSE buttons to make the tempo faster.

RECORDING/PLAYING BACK THE LEFT AND RIGHT HAND PARTS SEPARATELY

The CN piano can record the parts played by the left or right hand and play back these parts separately or simultaneously. This function can be enjoyed in different ways. For example, you can practice the right-hand part of the song while playing back the recorded left-hand part, or record the melody part of the song while playing back the previously recorded accompaniment.

- (1) While holding down the REC button, press the E.PIANO (Song 3) button to select Song No.3. Part 1 of Song No.3 will be selected and the CN piano will be ready to record. To cancel without recording, press the REC button again.
- (2) Play the piano with your left hand. Playing the piano will automatically start the recording. You can also start recording by pressing the PLAY/STOP button.
- (3) Press the PLAY/STOP button after you have finished recording.
- (4) Now, to play back the left-hand part, press the PLAY/STOP button. The left-hand part you have recorded (Part 1 of Song No.3) will be played back. You can practice the right-hand part along with the recorded part.

You can adjust the tempo. Before pressing the PLAY/STOP button, press the STRING button while holding down the TOUCH and TRANSPOSE buttons to make the tempo slower or press the CHOIR button while holding down the TOUCH and TRANSPOSE buttons to make the tempo faster.

(5) Let's record the right-hand part while listening to the left-hand part. While holding down the REC button, press the CHOIR (Part 2) button. The Part 1 LED will light and the Part 2 LED will flash to indicate that the piano is ready to record. To cancel without recording, press the REC switch again.

(6) Now play the right-hand part. Pressing any key will start play back of the recorded left-hand part (Part 1) while you play (and record) the right-hand part. You can also start recording by pressing the PLAY/STOP button. After pressing the PLAY/STOP button the left-hand part will begin playing back, you can then begin playing (recording) the right hand part from any point in the song you like.

(7) Press the PLAY/STOP button after you have finished recording.

PLAYING BACK THE LEFT- AND RIGHT-HAND PARTS SEPARATELY

After you have recorded the left- and right-hand parts (Part 1 and Part 2) separately, it is possible to play back the two parts by themselves or together. The following example shows how to play back only Part 2.

(1) Select and press one of the Song buttons (CLASSIC GRAND/Song 1, MODERN PIANO/Song 2 or E.PIANO/Song 3) while pressing the PLAY/STOP button.

(2) While holding down the PLAY/STOP button, press the STRING/Part 1 button.

The STRING/Part 1 button LED will be turned "off". If you need to turn Part 1 back "on", press the STRING/Part 1 button once again.

(3) Releasing both buttons will play back only Part 2.

You can adjust the tempo. Before pressing the PLAY/STOP button, press the STRING button while holding down the TOUCH and TRANSPOSE buttons to make the tempo slower or press the CHOIR button while holding down the TOUCH and TRANSPOSE buttons to make the tempo faster.

4. DELETING A SONG/TRACK

This function allows you to delete songs that were not recorded correctly or songs that you do not want to listen to any more.

(1) Simultaneously hold down the PLAY/STOP and REC buttons.

(2) The LEDs will light to show you where songs have been recorded.

While holding down both the PLAY/STOP and REC buttons, press the song button that corresponds to the song you want to delete.

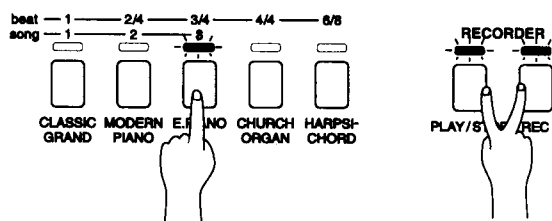

(3) While still holding down both the PLAY/STOP and REC buttons, press the part button that you want to delete and turn the LED lamp above that part button off.

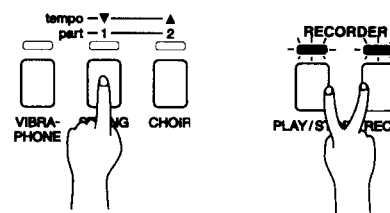

(4) Releasing all the buttons will delete the specified song or part.

To delete more than one song, repeat (1) to (4).

NOTE:

- The total memory capacity of the recorder is approximately 1,800 notes. When the recorder reaches its maximum capacity, the CN piano will stop recording at this point. Any data recorded before the interruption will be retained.
- The recorder memory will be saved after turning off the power. However, memory may be lost if the power remains off for more than 10 days.
- To delete all recorded songs (reset), first turn the power off and then turn it back on again while holding down both the PLAY/STOP and REC buttons.

PROGRAMMING MODE

The Programming Mode gives you access to many other useful features on your CN piano. To use the Programming Mode functions, press a key on the keyboard while holding down the TOUCH and TRANSPOSE buttons. To exit the Programming Mode, release the TOUCH and TRANSPOSE buttons.

The following functions can be selected in the Programming Mode:

- SELECTING A TOUCH TYPE (C or D or E key)
- TUNING (C-sharp or E-flat key)
- MIDI CHANNEL SELECT (F or G or A key)
- TRANSMIT MIDI PROGRAM CHANGE ON/OFF (B-flat key)
- MULTI TIMBRAL MODE ON/OFF (A-flat key)
- MIDI LOCAL CONTROL ON/OFF (F-sharp key)
- RESET (B key)

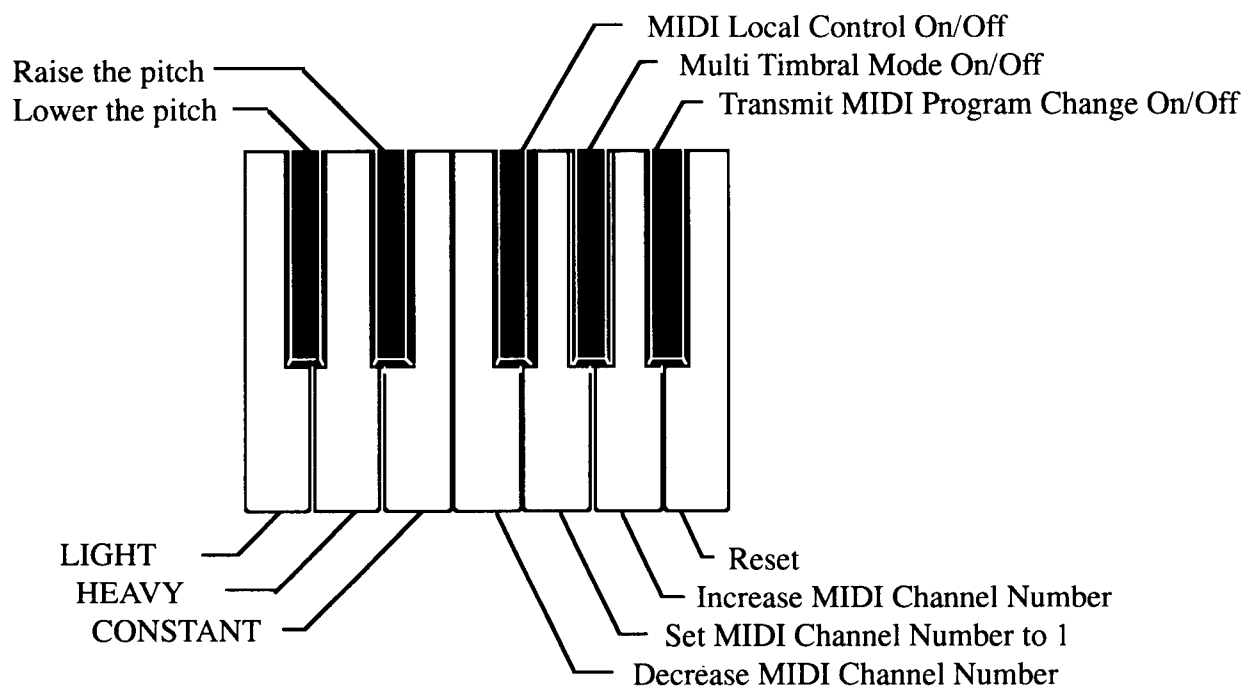

1. SELECTING A TOUCH TYPE

Your CN piano lets you select from four different “Touch” types as follows:

- NORMAL:** The standard setting which produces volume in direct proportion to your force on the keys. This setting is the most similar to an acoustic piano. The CN piano automatically selects this Touch Type when the power is turned on.
- LIGHT:** For those still developing finger strength, such as a child, a louder sound is produced even when the piano is played with a soft touch.
- HEAVY:** Perfect for those with strong fingers or for practicing with a hard touch.
- CONSTANT:** For tone colors like organ or harpsichord, and for playing some contemporary music with the piano sound, a constant loud sound is produced regardless of your force on the keys.

(1) To select the “LIGHT”, “CONSTANT” or “HEAVY” Touch Type, press one of the following keys on the keyboard while holding down the TOUCH and TRANSPOSE buttons.

Any C key: Selects the “LIGHT” Touch Type

Any D key: Selects the “HEAVY” Touch Type

Any E key: Selects the “CONSTANT” Touch Type

(2) Release both hands after selecting the Touch Type to exit the programming mode.

When the TOUCH LED is off, the “NORMAL” Touch Type is automatically selected. When an alternative touch type is selected using the above procedure, the TOUCH LED will light. The TOUCH button is a toggle switch. Pressing the button turns on the LED. Pressing it a second time turns off the LED.

2. TUNING

This function allows you to adjust the piano’s pitch to match recordings or other instruments in an ensemble.

(1) To lower the pitch press any C-sharp key while holding down the TOUCH and TRANSPOSE buttons. To raise the pitch press any E-flat key while holding down the TOUCH and TRANSPOSE buttons.

(2) Release the both hands after finding the desired pitch.

The range of tuning is +/-50 cents (100 cents = a half tone). Each press of the key will change the tuning 1.56 cents. Press the key repeatedly until you arrive at the desired pitch.

3. MIDI CHANNEL SELECT

In order to exchange MIDI information with another MIDI instrument, you must first set the two connected instruments to the same channel.

(1) If you press any A key while holding down the TOUCH and TRANSPOSE buttons, the MIDI channel will increase by one each time you press the key. MIDI channel will progress from 1 to 16. If you press any G key, the channel will be set to 1 regardless of what channel is currently selected. And, if you press any F key while holding down the TOUCH and TRANSPOSE buttons, the MIDI channel will decrease by 1 each time you press the key.

(2) Release the both hands after selecting the channel.

When the power is first turned on, the CN piano always selects channel 1.

4. TRANSMIT MIDI PROGRAM CHANGE ON/OFF

You can use 8 tone buttons to transmit Program Change Numbers via MIDI. Please refer to the list below for assignment of tone and program number.

STONE NAME	PRG #	PRG #(When Multi-Timbral mode is ON)
CLASSIC GRAND	1	1
MODERN PIANO	2	2
E.PIANO	3	5
CHURCH ORGAN	4	20
HARPSICHORD	5	7
VIBRAPHONE	6	12
STRING	7	49
CHOIR	8	53

(1) If you press any B-flat key while holding down the TOUCH and TRANSPOSE buttons, this function is set to “off” and the CN piano does not transmit the program change data corresponding to the tone selected on the panel. If you press the B-flat key again while holding down the TOUCH and TRANSPOSE buttons, this function returns to “on” and selecting a tone will transmit the data.

(2) Release both hands after selecting either “on” or “off” for transmit MIDI program change. When the power is first turned on, the TRANSMIT MIDI PROGRAM CHANGE function is always “on”.

5. TURNING MULTI-TIMBRAL MODE ON/OFF

Normally, the procedure described in the MIDI CHANNEL SELECT section is used to transmit or receive data on only one MIDI channel (any one of 1 through 16). But by turning the MULTI TIMBRAL function “on”, you can receive data on more than one MIDI channel and simultaneously play a different sound on each channel. With this feature, you can use a sequencer such as the Kawai Q-80EX or DRP-10 to create performances with a variety of timbres on the CN piano. The term “Multi Timbral” is derived from the ability to play multiple timbres simultaneously.

NOTE:

You can assign any tone of the CN piano to any channel in the way you like by sending the correct Program Change Number to the CN piano from an external MIDI device. Please refer to the list above for assignment of tone and program number.

(1) If you press any A-flat key while holding down the TOUCH and TRANSPOSE buttons, the MULTI-TIMBRAL MODE will be set to “on”. If you press any A-flat key again while holding down the TOUCH and TRANSPOSE buttons, the MULTI-TIMBRAL MODE returns to “off”.

(2) Release both hands after selecting the desired setting. When power is first turned on, the MULTI-TIMBRAL MODE setting is always off.

6. MIDI LOCAL CONTROL ON/OFF

This function is used to control whether or not the sound from the piano will be heard when you play the keyboard. When MIDI LOCAL CONTROL is set to on you will hear the CN piano when you play. When MIDI LOCAL CONTROL is set to off you will not hear any sound from the CN piano when you play but the CN piano's keyboard data will be transmitted through the MIDI jacks to an external MIDI device.

(1) If you press any F-sharp key while holding down the TOUCH and TRANSPOSE buttons, the MIDI LOCAL CONTROL will be set to “off”. If you press again any F-sharp key while holding down the TOUCH and TRANSPOSE buttons, the MIDI LOCAL CONTROL returns to “on”.

(2) Release both hands after selecting the desired setting.

7. RESET

When the RESET procedure is used, most of the CN piano's original factory settings (the same setting as when you turn on the instrument) will be restored.

The original factory settings restored with this function are:

– MIDI Transmit Channel	1
– Transmit MIDI Program Change	On
– Multi-timbral Mode	Off
– MIDI Local Control	On
– Tuning	+/-0
– Touch Type (When the TOUCH LED is on)	LIGHT
– Tempo (Metronome of the Recorder)	120/min.

(1) Press any B-key while holding down the TOUCH and TRANSPOSE buttons.

(2) Release both hands after following this procedure.

MIDI

The term MIDI is an acronym for Musical Instrument Digital Interface, an international standard for connecting synthesizers, sequencers (digital recorders) and other electronic instruments so that they can exchange performance data.

The CN270 is equipped with two MIDI jacks for exchanging data: MIDI IN and MIDI OUT. Each uses a special cable with a DIN connector.

MIDI IN : For receiving note, program change and other data.

MIDI OUT : For sending note, program change and other data.

MIDI EXAMPLES

(1) Connection to another MIDI compatible keyboard or sound generator module

When connected as shown in the illustration, data on how the digital piano is played (which keys are struck) can be sent to another MIDI instrument. Plus, the sound from the CN270 can be layered over the sound of the other instrument.

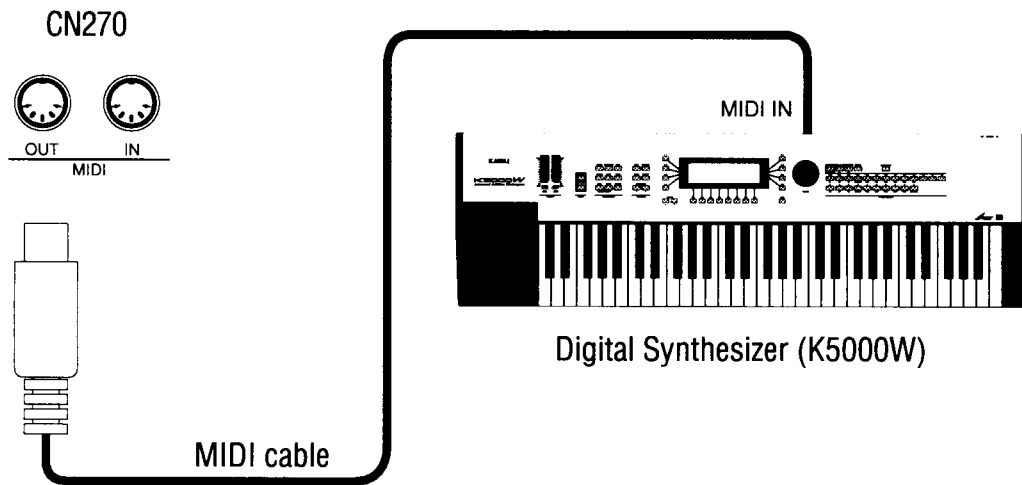

Layering Sounds

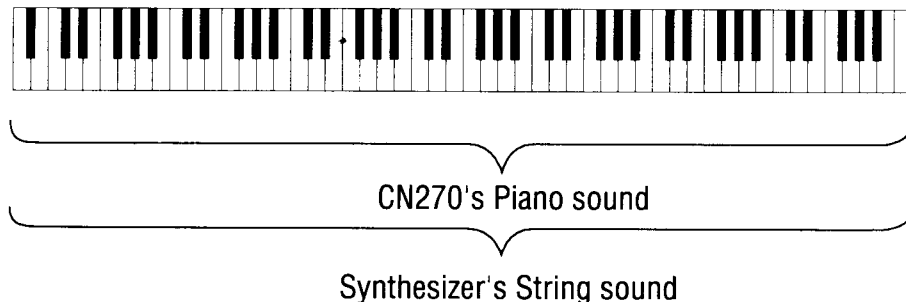

(2) Connection to an external sequencer and sound generator module

When connected as shown in the illustration, you can record songs played on the CN270 with a sequencer, and use the CN270's tones (such as piano, harpsichord and vibraphone, etc.) controlled by the CN270's MULTI-TIMBRAL MODE function to create a multi-layer MIDI recording. In case you use the KAWAI DRP-10 or ACR-20, you can play its tones from the keyboard of the CN270.

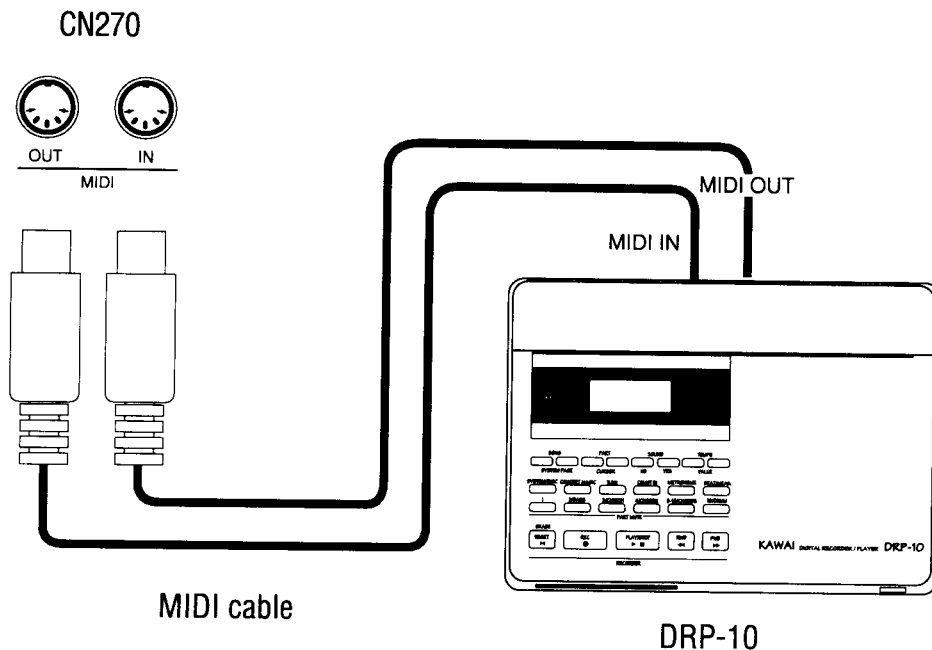

SPECIFICATIONS

Keyboard	88 Weighted Keys with Hammer Mechanism
Touch Type	4 Types (Normal, Light, Heavy, Constant)
Max Polyphony	32 Notes
Tones	8 Tones (CLASSIC GRAND, MODERN PIANO, E.PIANO, CHURCH ORGAN, HARPSICHORD, VIBRAPHONE, STRING, CHOIR)
Effects	Reverb (Room, Stage, Hall), Chorus
Digital Recorder	3-Song, 2-Part, 1,800-Notes
Other Functions	Transpose, Tuning, MIDI Functions, 8 Demo Songs
Pedals	2 (Soft or Sostenuto, Sustain)
Jacks	Headphones x 2, Pedal, MIDI IN/OUT, LINE IN/OUT (L, R)
Speakers	12 cm x 2 (4 3/4"), 15 W x 2
Dimensions	139 x 46 x 99 (cm), 55" x 18" x 39"
Weight	38.5 kg (85 lbs.)

Specifications are subject to change without notice.

MIDI IMPLEMENTATION CHART

KAWAI DIGITAL PIANO
MODEL: CN270

Date: June 2000
Version: 1.0

FUNCTION	TRANSMITTED	RECEIVED	REMARKS
Basic Channel (Default) (Changed)	1 1-16	1 1-16	
Mode (Default) (Message) (Altered)	3 x *****	1 1, 3*	*Omni Off by setting MIDI channel
Note Number (True Voice)	15-113* *****	0-127 15-113	*with Transpose
Velocity (Note ON) (Note OFF)	O: 9nH v=1-127 x: 8nH v=0	O x	
After Touch Key's Channel's	x x	x x	
Pitch Bend	x	x	
Control Change 7 64 66 67	x O (Right pedal) O (Left pedal) O (Left pedal)	O O x O	Volume Damper pedal Sosutenuto pedal Soft pedal
Program Change True	O *****	O	
System Exclusive Common (Song Position) (Song Select) (Tune)	O x x x	O x x x	
System: Real Time (Clock) (Commands)	x x	x x	
Others (Local ON/OFF) (All Notes OFF) (Active Sense) (Reset)	x x O x	O O* O* x	*When Multi-Timbral mode is On

Mode 1: OMNI ON, POLY Mode 2: OMNI ON, MONO
Mode 3: OMNI OFF, POLY Mode 4: OMNI OFF, MONO

KAWAI