

KAWAI

DIGITAL PIANO

CN 21

Owner's Manual

PART NAMES
AND FUNCTIONS
1

GETTING STARTED
2

LESSON FUNCTION
3

RECORDER
4

FUNCTION MODE
5

APPENDICES
6

THANK YOU FOR PURCHASING A KAWAI DIGITAL PIANO!

This KAWAI digital piano is a revolutionary new keyboard instrument, combining the latest in electronic advances with traditional craftsmanship inherited from KAWAI's many years of experience building fine pianos. The CN21 keyboard provides the touch response and full dynamic range required for a superb performance of piano, harpsichord, organ, and other instruments. The CN21's Lesson function helps performers to practice the piano with a collection of etudes from Czerny and Burgmüller, or songs from *Alfred's Basic Piano Library* lesson book (USA, Canada, Australia and UK only).

In addition, the CN21 piano is equipped with reverb and digital effects processors, providing an unrivalled richness of sound. Industry standard MIDI (Musical Instrument Digital Interface) jacks are included, allowing a number of other electronic instruments to be controlled and played simultaneously, creating a range of musical possibilities.

This Owner's Manual contains valuable information to help performers make full use of the instrument's many capabilities. Please read all sections carefully and keep this manual handy for future reference.

Table of Contents

1. PART NAMES AND FUNCTIONS8	5. FUNCTION MODE24
◇ CONTROL PANEL 8	1) BASIC OPERATIONS 24
◇ USING THE ENCLOSED FUNCTION LABEL 8	2) SELECTING A TOUCH TYPE 25
◇ PEDALS 9	3) TRANSPOSE..... 25
2. GETTING STARTED..... 10	4) TUNING 26
1) BASIC OPERATIONS..... 10	5) REVERB 26
◇ DEMONSTRATION SONGS..... 11	6) CONCERT MAGIC MODE 27
◇ SELECTING A SOUND 12	7) MIDI CHANNEL SELECT 27
2) DUAL 13	◇ About MIDI 27
3) METRONOME 14	◇ CN21 MIDI functions..... 27
◇ CHANGING THE BEAT (TIME SIGNATURE) 14	8) MIDI LOCAL CONTROL ON/OFF 28
◇ ADJUSTING THE METRONOME TEMPO 15	9) TURNING MULTI-TIMBRAL MODE ON/OFF29
4) CONCERT MAGIC 16	10) TRANSMIT MIDI PROGRAM CHANGE 30
◇ SELECTING A SONG 16	6. APPENDICES.....31
◇ LISTENING TO THE SONG 16	1) CONNECTING TO OTHER DEVICES..... 31
◇ PERFORMING A SONG 17	2) ASSEMBLY INSTRUCTIONS..... 32
◇ CONCERT MAGIC SONG TYPES 17	3) CONCERT MAGIC SONG LIST 34
◇ CONCERT MAGIC DEMO MODES..... 18	4) LESSON SONG LIST..... 35
3. LESSON FUNCTION..... 19	◇ ALFRED'S BASIC PIANO LIBRARY..... 35
◇ SELECTING A LESSON SONG FROM THE FIRST	◇ BURGMÜLLER & CZERNY ETUDES 36
SONG BOOK..... 19	5) SPECIFICATIONS..... 37
◇ SELECTING A LESSON SONG FROM THE SECOND	6) MIDI IMPLEMENTATION CHART..... 38
SONG BOOK..... 19	
◇ LISTENING TO A LESSON SONG..... 20	
◇ EXITING THE LESSON FUNCTION 20	
◇ PRACTICING LEFT AND RIGHT-HAND PARTS 20	
◇ ADJUSTING THE TEMPO OF A LESSON SONG 21	
4. RECORDER22	
1) RECORDING A SONG..... 22	
2) PLAYING BACK A SONG 23	
3) ERASING A SONG 23	

Important Safety Instructions

SAVE THESE INSTRUCTIONS

INSTRUCTIONS PERTAINING TO A RISK OF FIRE, ELECTRIC SHOCK, OR INJURY TO PERSONS



WARNING

TO REDUCE THE RISK OF FIRE OR ELECTRIC SHOCK, DO NOT EXPOSE THIS PRODUCT TO RAIN OR MOISTURE.

AVIS : RISQUE DE CHOC ELECTRIQUE - NE PAS OUVRIR.

TO REDUCE THE RISK OF ELECTRIC SHOCK, DO NOT REMOVE COVER (OR BACK). NO USER-SERVICEABLE PARTS INSIDE. REFER SERVICING TO QUALIFIED SERVICE PERSONNEL.



The lightning flash with arrowhead symbol, within an equilateral triangle, is intended to alert the user to the presence of uninsulated "dangerous voltage" within the product's enclosure that may be of sufficient magnitude to constitute a risk of electric shock to persons.



The exclamation point within an equilateral triangle is intended to alert the user to the presence of important operating and maintenance (servicing) instructions in the literature accompanying the product.

Examples of Picture Symbols



denotes that care should be taken.
The example instructs the user to take care not to allow fingers to be trapped.



denotes a prohibited operation.
The example instructs that disassembly of the product is prohibited.



denotes an operation that should be carried out.
The example instructs the user to remove the power cord plug from the AC outlet.

Read all the instructions before using the product.

- 1) Read these instructions.
- 2) Keep these instructions.
- 3) Heed all warnings.
- 4) Follow all instructions.
- 5) Do not use this apparatus near water.
- 6) Clean only with dry cloth.
- 7) Do not block any ventilation openings. Install in accordance with the manufacturer's instructions.
- 8) Do not install near any heat sources such as radiators, heat registers, stoves, or other apparatus (including amplifiers) that produce heat.
- 9) Do not defeat the safety purpose of the polarized or grounding-type plug. A polarized plug has two blades with one wider than the other. A grounding type plug has two blades and a third grounding prong. The wide blade or the third prongs are provided for your safety. If the provided plug does not fit into your outlet, consult an electrician for replacement of the obsolete outlet.
- 10) Protect the power cord from being walked on or pinched particularly at plugs, convenience receptacles, and the point where they exit from the apparatus.
- 11) Only use attachments/accessories specified by the manufacturer.
- 12) Use only with the cart, stand, tripod, bracket, or table specified by the manufacturer, or sold with the apparatus. When a cart is used, use caution when moving the cart/apparatus combination to avoid injury from tip-over. 
- 13) Unplug this apparatus during lightning storms or when unused for long periods of time.
- 14) Refer all servicing to qualified service personnel. Servicing is required when the apparatus has been damaged in any way, such as power-supply cord or plug is damaged, liquid has been spilled or object have fallen into the apparatus, the apparatus has been exposed to rain or moisture, does not operate normally, or has been dropped.

WARNING - When using electric products, basic precautions should always be followed, including the following.



WARNING

Indicates a potential hazard that could result in death or serious injury if the product is handled incorrectly.

The product should be connected to an AC outlet of the specified voltage.



- If you are going to use an AC power cord, make sure that it has the correct plug shape and conforms to the specified power voltage.
- Failure to do so may result in fire.

Do not insert or disconnect the power cord plug with wet hands.



Doing so may cause electric shock.

The chair must be used properly (it must be used only when playing the product).

- Do not play with it or stand on it.
- Only one person is allowed to sit on it.
- Do not sit on it when opening the lid.
- Re-tighten the bolts occasionally.

Doing so may cause the chair to fall over or your fingers to be trapped, resulting in injury.

When using the headphones, do not listen for long periods of time at high volume levels.

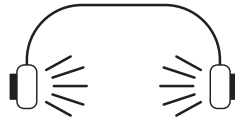

Doing so may result in hearing problems.

Do not lean against the keyboard.



Doing so may cause the product to fall over, resulting in injury.

Do not disassemble, repair or modify the product.



Doing so may result in product breakdown, electric shock or short-circuit.

When disconnecting the AC power cord's plug, always hold the plug and pull it to remove it.



- Pulling the AC power cord itself may damage the cord, causing a fire, electric shock or short-circuit.

The product is not completely disconnected from the power supply even when the power switch is turned off. If the product will not be used for a long time, unplug the AC power cord from the AC outlet.



- Failure to do so may cause fire in case of lightning.
- Failure to do so may over-heat the product, resulting in fire.

This product may be equipped with a polarized line plug (one blade wider than the other). This is a safety feature. If you are unable to insert the plug into the outlet, contact an electrician to replace your obsolete outlet. Do not defeat the safety purpose of the plug.

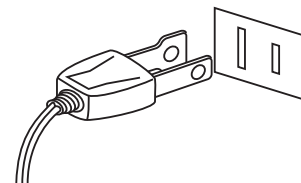

It is a good practice to have the instrument near the AC outlet and the power cord plug in a position so that it can readily be disconnected in an emergency because electricity is always charging while the plug is in the AC outlet even in a power switch off condition.



CAUTION

Indicates a potential hazard that could result in injury or damage to the product or other property if the product is handled incorrectly.

Do not use the product in the following areas.

- Areas, such as those near windows, where the product is exposed to direct sunlight
- Extremely hot areas, such as near a heater
- Extremely cold areas, such as outside
- Extremely humid areas
- Areas where a large amount of sand or dust is present
- Areas where the product is exposed to excessive vibrations

Using the product in such areas may result in product breakdown. Use the product only in moderate climates (not in tropical climates).

When you close the keyboard cover, close it gently.



Closing it roughly may trap your fingers, resulting in injury.

Before connecting cords, make sure that the power to this product and other devices is turned OFF.

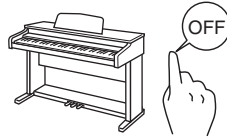

Failure to do so may cause breakdown of this product and other devices.

Take care not to allow any foreign matter to enter the product.

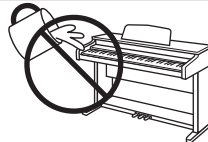

Entry of water, needles or hair pins may result in breakdown or short-circuit. The product shall not be exposed to dripping or splashing. No objects filled with liquids, such as vases, shall be placed on the product.

Do not drag the product on the floor. Take care not to drop the product.



Please lift up the product when moving it. Please note that the product is heavy and must be carried by more than two persons. Dropping the product may result in breakdown.

Do not place the product near electrical appliances such as TVs and radios.

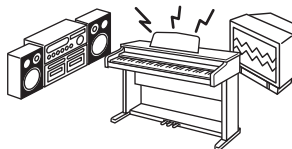

- Doing so may cause the product to generate noise.
- If the product generates noise, move the product sufficiently away from the electrical appliance or connect it to another AC outlet.

When connecting the AC power cord and other cords, take care not to get them tangled.



Failure to do so may damage them, resulting in fire, electric shock or short-circuit.

Do not wipe the product with benzene or thinner.



- Doing so may result in discoloration or deformation of the product.
- When cleaning the product, put a soft cloth in lukewarm water, squeeze it well, then wipe the product.

Do not stand on the product or exert excessive force.



- Doing so may cause the product to become deformed or fall over, resulting in breakdown or injury.

Do not place naked flame, such as lighted candles on the product.

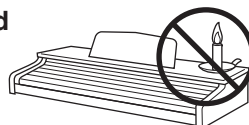

Doing so may cause the illumination to fall over, resulting in fire.

Ensure that the ventilation is not impeded by covering the ventilation openings with items, such as newspaper, table-cloths, curtains, etc.

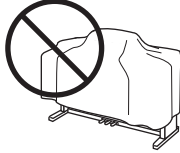

Failure to do so may over-heat the product, resulting in fire.

The product should be located so that its location or position does not interfere with its proper ventilation. Ensure a minimum distance of 5cm around the product for sufficient ventilation.

The product should be serviced by qualified service personnel when:

- The power supply cord or the plug has been damaged.
- Objects have fallen, or liquid has been spilled into the product.
- The product has been exposed to rain.
- The product does not appear to operate normally or exhibits a marked change in performance.
- The product has been dropped, or the enclosure damaged.

Notes on Repair

Should an abnormality occur in the product, immediately turn the power OFF, disconnect the power cord plug, and then contact the shop from which the product was purchased.

CAUTION:

To prevent electric shock, match wide blade of plug to wide slot, fully insert.

ATTENTION:

Pour éviter les chocs électriques, introduire la lame la plus large de la fiche dans la borne correspondante de la prise et pousser jusqu'au fond.

Instruction for AC power cord (U.K.)

Do not plug either terminal of the power cord to the ground of the AC outlet on the wall.

FCC Information

This equipment has been tested and found to comply with the limits for a Class B digital device, pursuant to Part 15 of the FCC Rules. These limits are designed to provide reasonable protection against harmful interference in a residential installation. This equipment generates, uses and can radiate radio frequency energy and, if not installed and used in accordance with the instructions, may cause harmful interference to radio communications.

If this equipment does cause harmful interference to radio or television reception, which can be determined by turning the equipment off and on, the user is encouraged to try to correct the interference by one or more of the following measures:

- Reorient or relocate the receiving antenna.
- Increase the separation between the equipment and receiver.
- Connect the equipment into an outlet on a different electrical circuit from the receiver.
- Consult the dealer or an experienced radio/TV technician for help.

Canadian Radio Interference Regulations

This instrument complies with the limits for a class B digital apparatus, pursuant to the Radio Interference Regulations, C.R.C., c. 1374.



An information on Disposal for users

If your product is marked with this recycling symbol it means that, at the end of its life, you must dispose of it separately by taking it to an appropriate collection point. You should not mix it with general household waste. Disposing of this product correctly will prevent potential negative effects on the environment and human health which could otherwise arise due to inappropriate waste handling.

For further details, please contact your local authority.
(European Union only)

1. PART NAMES AND FUNCTIONS

This section explains the locations and functions of the panel sliders and buttons.

◇ CONTROL PANEL

● CONCERT MAGIC

Press the CONCERT MAGIC button to enjoy listening to or performing a collection of pre-programmed piano songs. Concert Magic will provide the correct melody and accompaniment notes, regardless of which keys are pressed. (Page 16)

● RECORDER

The PLAY/STOP button is used to start/stop playback of the recorded song. The REC button is used for recording performances. (Page 22)

● METRONOME

Use this button to turn the metronome on/off. (Page 14)

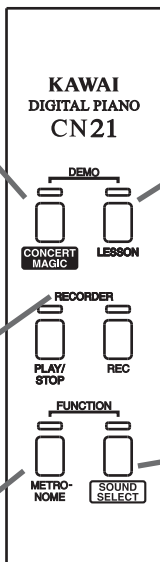

● LESSON

Press the LESSON button to access the etudes or Alfred lesson books (USA, Canada, UK, AU only), for an enjoyable piano lesson experience. (Page 19)

● SOUND SELECT

Select the desired instrument by pressing this button repeatedly, or by holding down this button and pressing one of the lowest fifteen white keys. (Page 12)

CONCERT GRAND	1/4	STUDIO GRAND	MODERN PIANO	2/4	ROCK PIANO	3/4	CLASSIC E.PIANO	MODERN E.PIANO	4/4	JAZZ ORGAN	5/4	CHURCH ORGAN	3/8	HARPSICHORD	VIBRA-PHONE	6/8	STRING ENSEMBLE	Vol+	SLOW STRINGS
off/-		on/+		1	2	3	4	5	6	7	8	9	0	1	2	3	4	5	6

function label

◇ USING THE ENCLOSED FUNCTION LABEL

A 'function label' is included with the CN21. Placing this label at the back of the keyboard will prove useful when selecting different sounds or changing values, such as the metronome time signature.

Position the function label so that the left end, marked 'CONCERT GRAND (off/-)' is aligned with the lowest key. The underside of the function label is sticky, allowing this information to be attached to the CN21 instrument for greater convenience.

CONCERT GRAND	1/4	STUDIO GRAND	MODERN PIANO	2/4	ROCK PIANO	3/4	CLASSIC E.PIANO	MODERN E.PIANO	4/4	JAZZ ORGAN	5/4	CHURCH ORGAN	3/8	HARPSICHORD	VIBRA-PHONE	6/8	STRING ENSEMBLE	Vol+	SLOW STRINGS
off/-		on/+	1	2	3	4	5	6	7	8	9	0	1	2	3	4	5	6	

Vol+	NEW AGE PAD	ATMOSPHERE	REVERB	CONCERT MAGIC	CH	Local	Multi	Program	METRONOME SOUNDS
CHOIR TOUCH	TRANSPOSE	TUNING							FUNCTIONS

● HEADPHONE JACKS

There are two headphone jacks located on the left underside of the piano, allowing up to two pairs of headphones to be connected simultaneously.

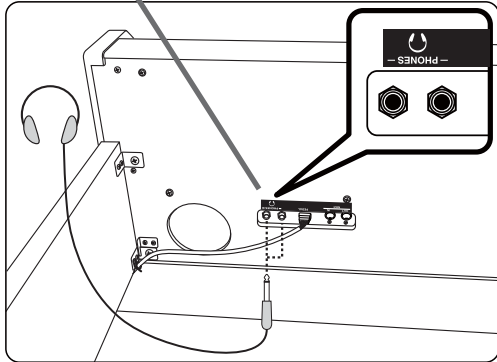

● POWER

Press this button to turn the power on/off. Be sure to turn off the instrument after playing.

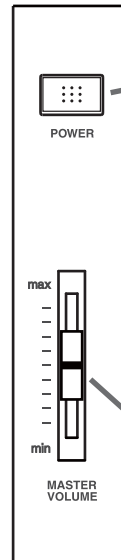

● MASTER VOLUME

This slider controls the master volume level of the built-in speakers and headphones. Move the volume slider upward to increase the instrument's volume, and downward to decrease the volume.

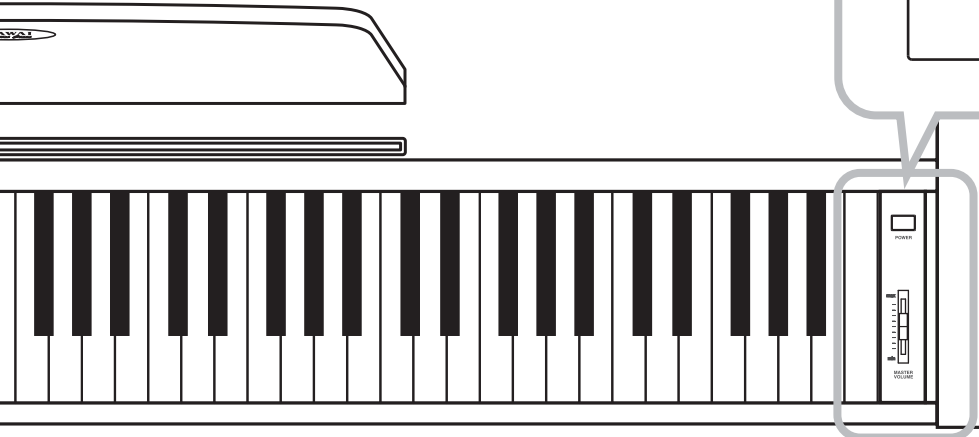

◇ PEDALS

The CN21 piano has three pedals—just like a grand piano. They are Sustain, Sostenuto and Soft.

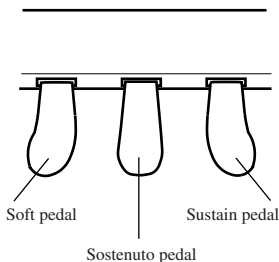

◆ Sustain pedal

Sustains the sound after hands are lifted from the keyboard. The sustain pedal is also capable of responding to half pedaling.

◆ Sostenuto pedal

Depressing this pedal after playing the keyboard and before releasing the keys sustains the sound of only the keys just played. Any keys that are pressed after the Sostenuto pedal is depressed will not be sustained after the keys are released.

◆ Soft pedal

Depressing this pedal softens the sound and reduces its volume.

2. GETTING STARTED

1) BASIC OPERATIONS

This section provides the basic procedures for turning the power on and playing the CN21 piano.

□ Step 1

Connect one end of the AC power cable to the piano's power jack and the other end of the cable to a wall AC outlet.

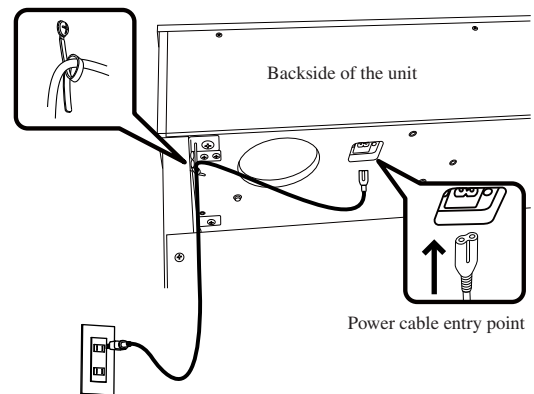

□ Step 2

Press the POWER button to turn the power on.



□ Step 3

Adjust the volume level using the MASTER VOLUME slider.

The MASTER VOLUME slider controls the volume level of the speakers and connected headphones. Set the volume to a comfortable listening level - the middle is often a good starting point.

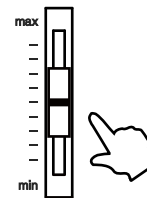

□ Step 4

Play the piano.

When power is turned on, the LED indicator for the SOUND SELECT button will turn on and the Concert Grand sound will be selected automatically.

A different sound can be selected by following the procedures described in 'SELECTING A SOUND' (page 12).

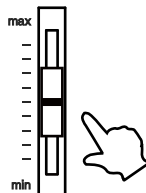
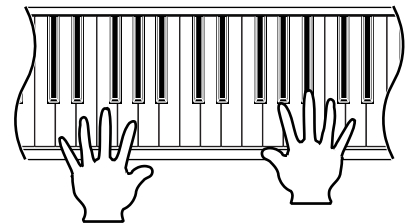

■ The CN21 piano is capable of playing up to 96 notes simultaneously (96-note polyphony).

◇ DEMONSTRATION SONGS

The CN21 piano includes 15 built-in demonstration songs for your listening pleasure. Each preset sound is introduced by a different piece of music, as shown below.

- Concert Grand.....Valse Romantique / Debussy
- Studio GrandKAWAI original
- Modern PianoKAWAI original
- Rock PianoKAWAI original
- Classic E.PianoKAWAI original
- Modern E.P.KAWAI original
- Jazz OrganKAWAI original
- Church OrganToccatà / Eugene Gigout
- HarpsichordFrench Suite No.6 / Bach
- VibraphoneKAWAI original
- String EnsembleLe quattoro stagioni 'La Primavera' / Vivaldi
- Slow Strings.....KAWAI original
- ChoirKAWAI original
- New Age Pad.....KAWAI original
- AtmosphereKAWAI original

KAWAI regret that sheet music for KAWAI original demo songs is not available.

□ Step 1

Press and hold the CONCERT MAGIC button, then press the LESSON button.

The song for Concert Grand will start to play.

When the Concert Grand demo song has finished, another demo song will be selected at random. This process will continue until all of the demo songs have been played.

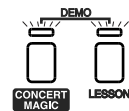

Press both buttons.

□ Step 2

While listening to a demo song, press the SOUND SELECT button to skip to the next demo song.

To listen to the demo song for a particular sound, press and hold the SOUND SELECT button, then press one of the lowest 15 keys assigned to the desired sound.

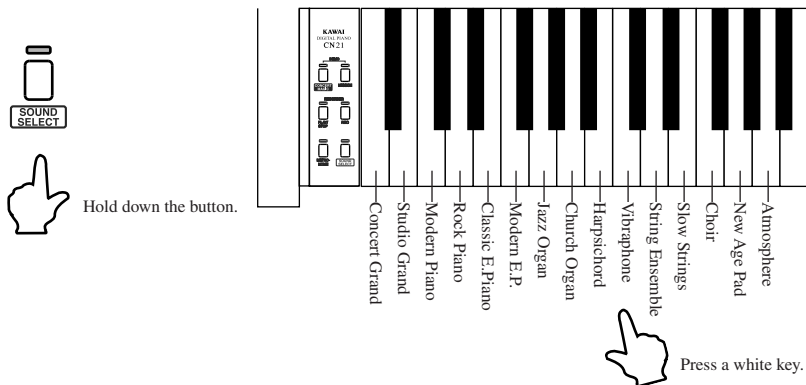

□ Step 3

To stop the demo, press either the CONCERT MAGIC button or the LESSON button.



Press one of buttons.

◆ SELECTING A SOUND

When power is turned on, the Concert Grand sound will be selected automatically.
There are 15 sound types and three methods to select different sounds.

◆ Method 1

Press and hold the SOUND SELECT button, then press one of the lowest 15 white keys to select a specific sound.

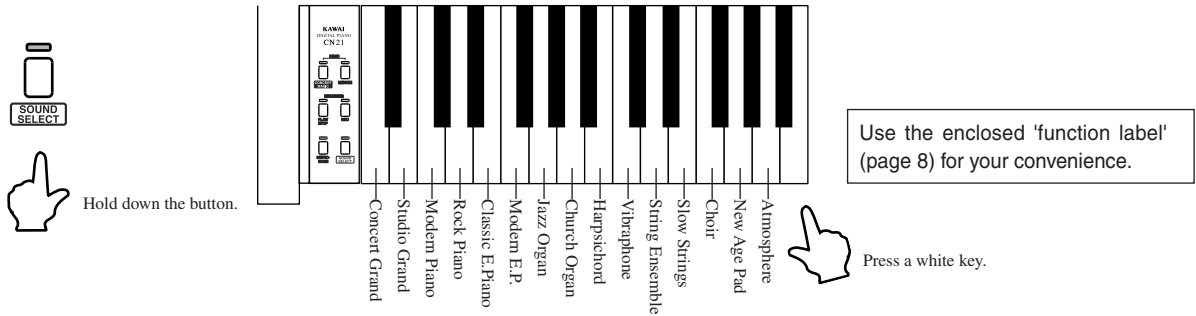

- The LED indicator for the SOUND SELECT button will turn on when Concert Grand is selected. When a sound other than Concert Grand is selected, the LED indicator for the SOUND SELECT button will start to flash.

◆ Method 2

Pressing the SOUND SELECT button once will change the sound sequentially. Press the SOUND SELECT button repeatedly to cycle through the 15 sounds until the desired sound is selected.

Power-on		Concert Grand (indicator ON)
When pressed once		Studio Grand (indicator flashes)
⋮	⋮	⋮
When pressed twice		Modern Piano (indicator flashes)
⋮	⋮	⋮
When pressed 7 times		Church Organ (indicator flashes)
⋮	⋮	⋮
When pressed 12 times		Choir (indicator flashes)
⋮	⋮	⋮
When pressed 15 times		Concert Grand (indicator ON)

◆ Method 3

Press and hold the SOUND SELECT button for more than one second to return to the Concert Grand sound.
The LED indicator for the SOUND SELECT button will turn on once again.

2) DUAL

The DUAL function allows two preset sounds to be layered together, creating a more complex sound. For example, a piano can be layered with strings, or a church organ with a choir sound.

□ Step 1

Press and hold the SOUND SELECT button, then, from the lowest 15 white keys, press the two keys assigned to the two desired sounds at the same time. The two sounds will be 'layered' together.

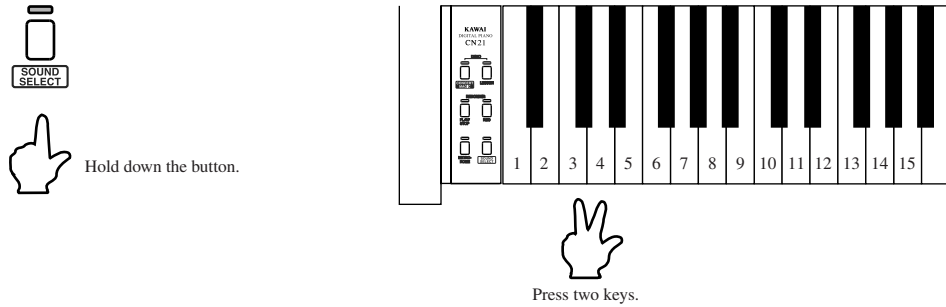

■ Please refer to the enclosed function label, or the sound allocation diagram on [page 8].

◆ Example: To layer Concert Grand and Jazz Organ sounds together.

Press and hold the SOUND SELECT button, then press the lowest white key (A) and the 7th key (G) at the same time.

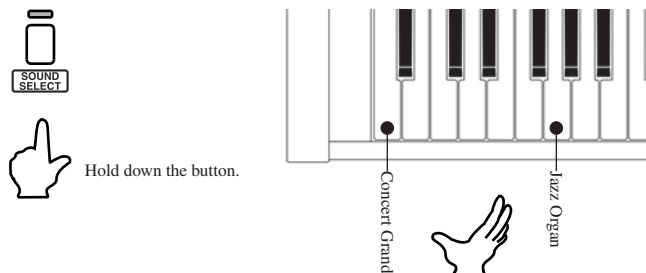

■ Press the SOUND SELECT button once to reset the sound type to Concert Grand.

3) METRONOME

The CN21 piano's metronome tool helps learners to practice playing the piano at the correct tempo by providing a steady beat to play along with.

- Step 1**
Press the METRONOME button to start the metronome.
- Step 2**
Press the METRONOME button once again to stop the metronome.

■ The metronome is set to a default beat of 1/4 and tempo of 120 each time the piano is turned on.

◇ CHANGING THE BEAT (TIME SIGNATURE)

The metronome beat (time signature) can be changed to one of seven different beats: 1/4, 2/4, 3/4, 4/4, 5/4, 3/8 and 6/8.

The volume level of the metronome can also be changed.

- Step 1**
Press and hold the METRONOME button, then select the desired beat (time signature) by pressing one of the lowermost black keys assigned to that beat.

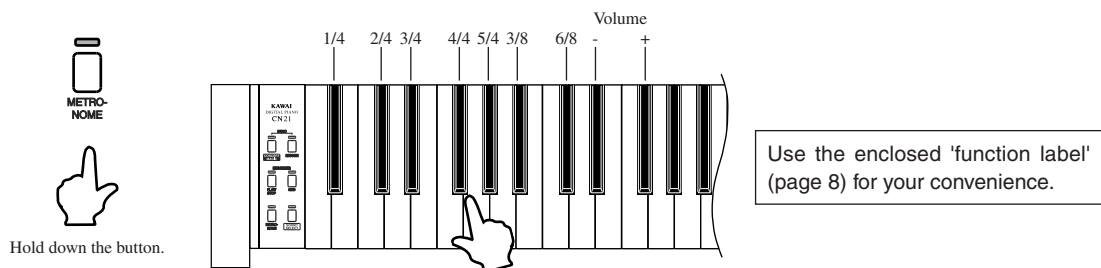

- Press and hold the METRONOME button, then press the fourth black key from the left to select a 4/4 beat.
- When the 1/4 beat is selected, only the click sound will be heard. The bell accent will not be heard.
- Press and hold the METRONOME button, then press the '-' and '+' to decrease or increase the volume of the metronome.

◇ ADJUSTING THE METRONOME TEMPO

The metronome has a tempo range of 10-300 beats per minute.

The metronome tempo can be specified precisely, or gradually decreased or increased.

□ Step 1

Press and hold the METRONOME button, then use the lower white keys to either enter the desired tempo in beats per minute (BPM), or gradually decrease or increase the tempo by pressing the '-' or '+' keys.

To set the metronome tempo, press and hold the METRONOME button, and input either a two-digit or three-digit tempo value.

The specified value will be set when the METRONOME button is released.

◆ Example: To set the metronome tempo to 136 beats per minute.

□ Method 1

Press and hold the METRONOME button, then press key 1, key 3 and key 6.
Release the METRONOME button.

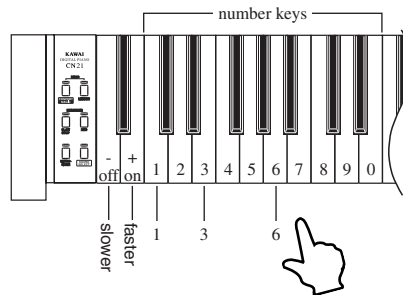
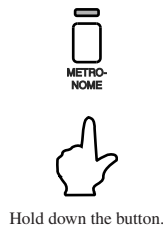

Use the enclosed 'function label' for your convenience. (page 8)

□ Method 2

Press and hold the METRONOME button, then press the '-' (off) or '+' (on) keys repeatedly to gradually decrease or increase the current tempo by 2 BPM.

4) CONCERT MAGIC

The great German composer Johann Sebastian Bach once said *"Playing the keyboard is simple. Just strike the right keys at the right time"*. Many pianists wish it were quite that straightforward. Fortunately, KAWAI have devised a method of playing the keyboard that is very simple, without even needing to strike the right keys.

With CONCERT MAGIC, absolutely anyone can sit at the CN21 piano and make real music - even complete beginners who have never taken a piano lesson in their life. To enjoy performing with Concert Magic, simply select one of the 40 pre-programmed songs and tap any key with a steady rhythm and tempo. Concert Magic will provide the correct melody and accompaniment notes, regardless of which keys are pressed. With Concert Magic anybody, young or old, can enjoy playing music from the moment they sit down at the CN21 piano.

◇ SELECTING A SONG

The 40 Concert Magic songs are assigned to each of the first 40 white keys, and classified by song category into six groups, such as Children's Songs, American Classics, Christmas Songs etc.

Please refer to Appendix 3: 'CONCERT MAGIC SONG LIST' on page 34 for a complete listing of available Concert Magic songs.

□ Step 1

Press and hold the CONCERT MAGIC button, then press one of the lowest 40 keys assigned to the desired Concert Magic song.

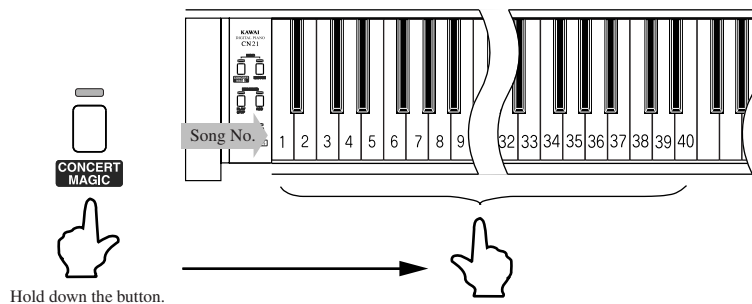

Hold down the button.

◇ LISTENING TO THE SONG

If the performer is already familiar with the selected Concert Magic song, he/she may wish to begin playing straight away. However, those unfamiliar with the piece may alternatively wish to listen to the song first, before attempting to play it.

□ Step 1

Press the PLAY/STOP button to listen to the selected Concert Magic song.

The CN21 piano will start to playback the selected Concert Magic song.
To listen to a different song, simply repeat the procedure above.

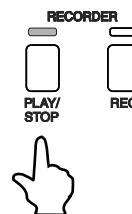

□ Step 2

Press the PLAY/STOP button or CONCERT MAGIC button once again to finish listening to the Concert Magic song.

◇ PERFORMING A SONG

□ Step 1

Tap out the rhythm of the selected song on any one of the piano's 88 black or white keys.

Concert Magic songs will respond to changes in playing style. As the keys are tapped harder, the music will grow louder; if the keys are tapped more softly, the music will become quieter. Tapping faster will cause the music to speed up, while tapping slower will make the music slow down accordingly. Using Concert Magic, even inexperienced pianists can sound like they have been playing for years, simply by pressing one key with one finger.

Concert Magic is a perfect method for small children to learn music, especially when developing a sense of rhythm. For older people who may believe it is too late to learn the piano, Concert Magic offers an enjoyable first step. With Concert Magic, the CN21 piano can be enjoyed by everyone in the family, even those who have never touched a musical instrument in their life.

◇ CONCERT MAGIC SONG TYPES

After playing with Concert Magic for a while, performers may feel that such playing is too easy and that there is very little to learn. While it is true that some of the songs are very easy to play, even for beginners, there are also some songs which will prove challenging, and require practice to play proficiently.

Each of the 40 Concert Magic songs fall into one of three different arrangement types, depending on the skill level required to perform them.

■ EASY BEAT

These are the easiest songs to play. To perform them, simply tap out a constant steady beat on any key on the keyboard.

Look at the following example, 'Für Elise'. Press the key with a steady sixteenth note rhythm.

Key on X X X X X X X X X X X X X X X X X X X X

■ MELODY PLAY

These songs are also quite easy to play, especially if they are familiar to the player. To perform them, tap out the rhythm of the melody on any key on the keyboard. Singing along as the rhythm is tapped can be helpful. Play 'Twinkle, Twinkle, Little Star' for example. Follow the melody's rhythm as shown.

Key on X X X X X X X X X X X X X X

When performing fast songs with Concert Magic, it is sometimes easier to tap two different keys with two alternating fingers in order to play at greater speed.

■ SKILLFUL

These songs range in difficulty from moderately difficult to difficult. To perform them, tap out the rhythm of both the melody and the accompaniment notes on any key on the keyboard, such as 'Waltz of the Flowers' shown below.

Key on X X X X X X X X X X X X

It may take a little practice to perform the Concert Magic songs proficiently. A good way to learn is to listen to these pieces first, and then try to tap out the rhythms that are heard.

Please refer to Appendix 3: 'CONCERT MAGIC SONG LIST' on page 34 for a complete listing of available Concert Magic songs. The arrangement type is marked next to each song title as 'EB' for Easy Beat, 'MP' for Melody Play and 'SK' for Skillful.

◇ CONCERT MAGIC DEMO MODES

There are three ways to listen to the Concert Magic songs in the DEMO mode.

■ ALL PLAY

Press the CONCERT MAGIC button and then press the PLAY/STOP button without selecting a song. The CN21 piano will play back all of the Concert Magic songs in order.

■ RANDOM PLAY

Press the CONCERT MAGIC button and then press the LESSON button. The CN21 piano will play back all of the Concert Magic songs in random order.

■ CATEGORY PLAY

Press and hold the CONCERT MAGIC button, press the piano key to which the desired song is assigned, and then press the LESSON button, before finally releasing the CONCERT MAGIC button. The CN21 piano will play back the selected song and then continue to play the rest of the songs in the same category.

To stop the demo, press the PLAY/STOP button.

3. LESSON FUNCTION

The CN21's Lesson function helps performers to practice the piano with a collection of etudes from Czerny and Burgmüller, or songs from *Alfred's Basic Piano Library* (USA, Canada, Australia and UK only).

It is possible to listen to each etude or song at various tempos, practicing the left and right hand parts separately.

Alfred's Basic Piano Library lesson book is sold separately. Please check with local dealers or contact Alfred's customer service by telephoning 818-892-2452 (USA & Canada), 0-95240033 (Australia), +44 (0) 279828960 (UK). Or alternatively, by e-mailing customerservice@alfred.com.

Lesson availability differs depending on geographical location:

	Book No.	Lesson Book Name
US, Canada,	1	Alfred's Basic Piano Library Lesson Book Level 1A
UK, Australia	2	Alfred's Basic Piano Library Lesson Book Level 1B
Rest of the World	1	Burgmüller: 25 Progressive Pieces, Opus 100
	2	Czerny: 30 Czerny Etudes de Mécanisme, Opus 849

Please refer to Appendix 4: 'LESSON SONG LIST' on page 35 for a complete listing of available Lesson Function songs.

◇ SELECTING A LESSON SONG FROM THE FIRST SONG BOOK

- Step 1
Press the LESSON button.

The LED indicator for the LESSON button will turn on, indicating that lesson mode is enabled, and the Concert Grand sound will be selected automatically.



- Step 2
Press and hold the LESSON button, then press the white key assigned to the desired lesson song.

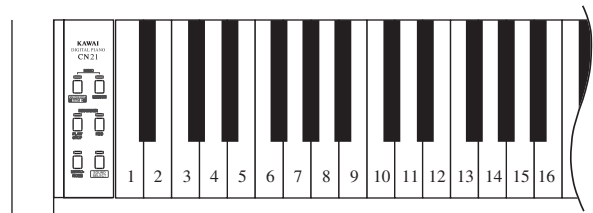
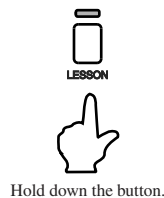

◇ SELECTING A LESSON SONG FROM THE SECOND SONG BOOK

- ◆ Example: To select lesson song No. 3

- Step 1
Press and hold the LESSON button, then press and hold one of the black keys, and finally press the white key assigned to the desired lesson song.

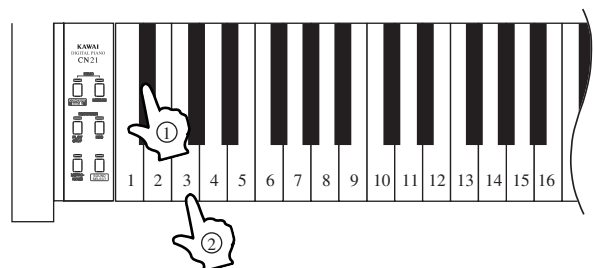
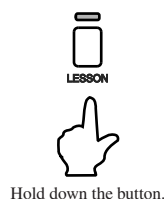

◇ LISTENING TO A LESSON SONG

Before practicing lesson songs, it is possible to listen to example performances.

- **Step 1**
Press the PLAY/STOP button.



The LED indicator for the PLAY/STOP button will turn on, and the currently selected song will start to play.



- **Step 2**
Press the PLAY/STOP button once again to stop the performance.

The LED indicator for the PLAY/STOP button will turn off.

- The metronome will play at the same tempo as that of the currently selected song.

◇ EXITING THE LESSON FUNCTION

- **Step 1**
Press the LESSON button.



The LED indicator for the LESSON button will turn off, and the CN21 piano will return to normal operation mode.



◇ PRACTICING LEFT AND RIGHT-HAND PARTS

When entering the lesson mode, the LED indicators for the METRONOME and SOUND SELECT button will start to flash, indicating that both the left-hand and right-hand parts of the selected lesson will be played.

◆ LISTENING TO THE LEFT-HAND PART OF A LESSON SONG

- **Step 1**
Press and hold the LESSON button, then press the METRONOME button.

The LED indicator for the METRONOME button will remain flashing, but the LED indicator for the SOUND SELECT button will turn off.

Release the LESSON button.

The left-hand part of the lesson song will be selected.

Press the PLAY/STOP button to play the selected lesson.

The left-hand part of the selected lesson will start to play, allowing the right-hand part to be practiced separately.

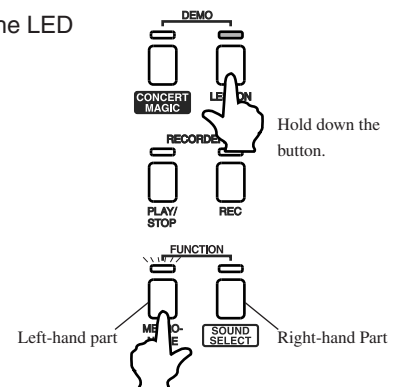

◆ LISTENING TO THE RIGHT-HAND PART OF A LESSON SONG

□ Step 1

Press and hold the LESSON button, then press the SOUND SELECT button.

The LED indicator for the SOUND SELECT button will remain flashing, but the LED indicator for the METRONOME button will turn off.

Release the LESSON button.

The right-hand part of the lesson song will be selected.

Press the PLAY/STOP button to play the selected lesson.

The right-hand part of the selected lesson will start to play, allowing the left-hand part to be practiced separately.

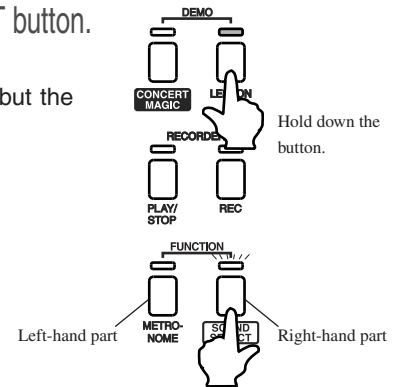

◆ LISTENING TO BOTH HANDS OF A LESSON SONG (RETURNING TO NORMAL PLAYBACK MODE)

□ Step 1

Press and hold the LESSON button, then press the SOUND SELECT and METRONOME buttons at the same time.

The LED indicators for both the SOUND SELECT and METRONOME buttons will start to flash.

Release the LESSON button.

Both the left-hand and right-hand parts of the lesson song will be selected.

- The CN21 piano will also return to normal playback mode if the LESSON button is pressed twice (exiting, and re-entering LESSON mode).

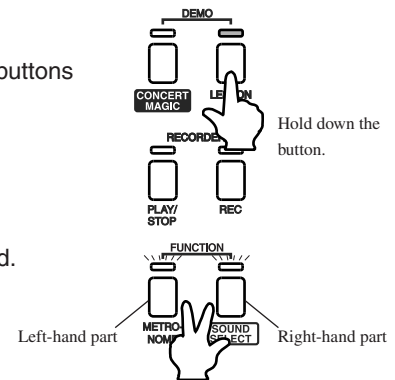

LESSON FUNCTION 3

◇ ADJUSTING THE TEMPO OF A LESSON SONG

□ Method 1

Press and hold the METRONOME button, then enter the desired tempo as a number using the number keys.

Release the METRONOME button.

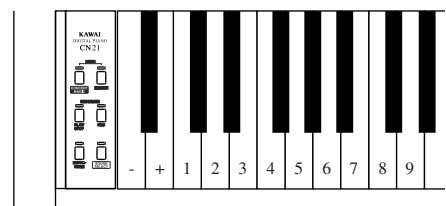
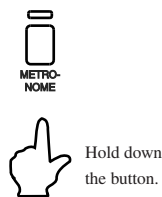

□ Method 2

Press and hold the METRONOME button, then press the '-' (off) or '+' (on) keys repeatedly to gradually decrease or increase the current tempo by 2 BPM.

Release the METRONOME button.



- Press and hold the METRONOME button, then press the '-' (off) and '+' (on) keys at the same time to reset the tempo of the lesson song.

Selecting the same lesson song again will also reset the tempo of the lesson song.

4. RECORDER

The RECORDER function records performances in a similar way to that of a tape recorder. However, the CN21 piano records songs as digital data, instead of audio data - storing the music inside the instrument, and providing a useful tool for both practicing and playing the piano.

1) RECORDING A SONG

- Step 1**
Press the REC button.

The LED indicator for the REC button will start to flash, indicating that the piano is in recording standby mode.

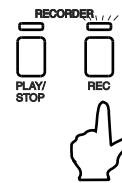

- Step 2**
Start to play the piano.

The recorder will automatically start recording with the first note played.

During this time, the LED indicators for the REC and PLAY/STOP buttons will be turned on.

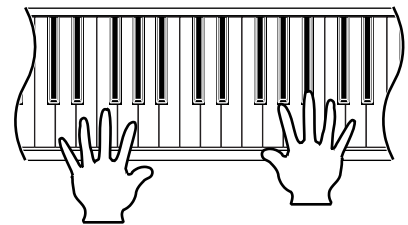

- The recording can also be started by pressing the PLAY/STOP button instead of pressing a key, allowing a blank bar to be inserted at the beginning of a song.

- Step 3**
Press the PLAY/STOP button to stop recording.

The CN21 piano will stop recording and the LED indicator for the REC button will flash momentarily while the song is saved to memory.

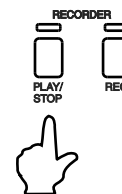

- The total recording capacity of the CN21 piano's memory is approximately 7,500 notes, with pedal presses also counted as one note. When the maximum capacity is reached, recording will stop and all music recorded up until that point will be saved to memory automatically.
- To record the piece again, simply repeat the above procedure. The new recording will completely erase the previous one.

2) PLAYING BACK A SONG

□ Step 1

Press the PLAY/STOP button to start playing the recorded song.

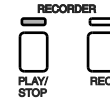

Press the PLAY/STOP button again to stop playback.



■ If the REC button is pressed again to start recording, the previously recorded song will be overwritten by the new song.

3) ERASING A SONG

The CN21 piano must be turned off in order to erase the recorded song.

□ Step 1

Turn the power off.

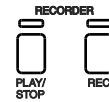

□ Step 2

Press and POWER button and hold down the PLAY/STOP and REC buttons at the same time.



Hold down the button.



The recorded song will be erased.

5. FUNCTION MODE

The Function Mode provides access to many other useful features of the CN21 piano.

1) BASIC OPERATIONS

□ Step 1

Press and hold the METRONOME and SOUND SELECT buttons at the same time, then press one of the 15 lowest keys assigned to the desired function.

The LED indicators for the METRONOME and SOUND SELECT buttons will start to flash while the settings are made.

- If the LED indicators for either the CONCERT MAGIC or LESSON buttons are turned on, the Function Mode cannot be used.

□ Step 2

While still holding down the METRONOME and SOUND SELECT buttons, press the '-' (off) or '+' (on) keys to change the value for the selected function.

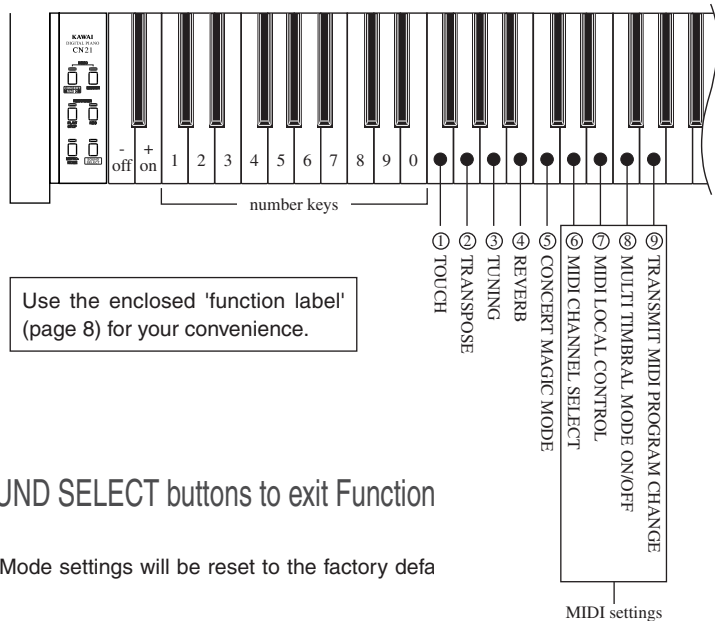
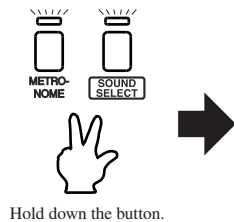

- While holding down the METRONOME and SOUND SELECT buttons, it is possible to select other functions, changing each value successively.

Use the enclosed 'function label' (page 8) for your convenience.

□ Step 3

Release both the METRONOME and SOUND SELECT buttons to exit Function

- When the power is turned off, Function Mode settings will be reset to the factory default values, shown below.

Function	Default
TOUCH	Normal
TRANSPOSE	0
TUNING	A4=440.0Hz
REVERB	On
CONCERT MAGIC MODE	Mode 1
MIDI CHANNEL SELECT	1ch
MIDI LOCAL CONTROL ON/OFF	On
MULTI TIMBRAL MODE ON/OFF	Off
TRANSMIT MIDI PROGRAM CHANGE	On

2) SELECTING A TOUCH TYPE

When playing a piano, the volume of the sound produced increases in direct relation to how hard each key is struck. The TOUCH function allows different touch sensitivities for the keyboard to be selected, other than the standard touch of an acoustic piano. The sensitivity can be changed to one of four different settings: Light, Normal, Heavy or Constant.

□ Step 1

Press and hold the METRONOME and SOUND SELECT buttons at the same time, then press the key assigned to the TOUCH function.

□ Step 2

While still holding down the METRONOME and SOUND SELECT buttons, press one of the following keys:

◆ Key1: LIGHT

For those still developing finger strength, such as a child, a louder sound is produced even when the piano is played with a soft touch.

◆ Key2: NORMAL

The standard setting, reproducing the touch sensitivity of an acoustic piano. This touch type is selected automatically when the CN21 piano is turned on.

◆ Key3: HEAVY

Perfect for those with strong fingers or for practicing with a hard touch.

◆ Key4: CONSTANT

This setting is suitable for sounds that have a fixed dynamic range, such as Organ and Harpsichord. A constant volume is produced regardless of how hard the keys are struck.

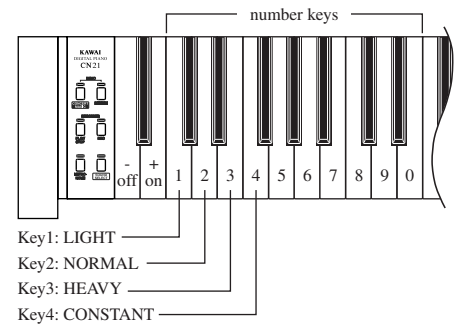

■ The touch type is automatically set to NORMAL when the CN21 piano is turned on.

3) TRANSPOSE

The transpose function allows the piano's keys to be raised or lowered in half steps. This is particularly useful when accompanying instruments with different tones, or when a song learned in one key must be played in another key. The transpose feature allows the song to be played in the original key, but heard in another key.

□ Step 1

Press and hold the METRONOME and SOUND SELECT buttons at the same time, then press the key assigned to the TRANSPOSE function.

□ Step 2

While still holding down the METRONOME and SOUND SELECT buttons, press a key on the keyboard to select the desired transposed key.

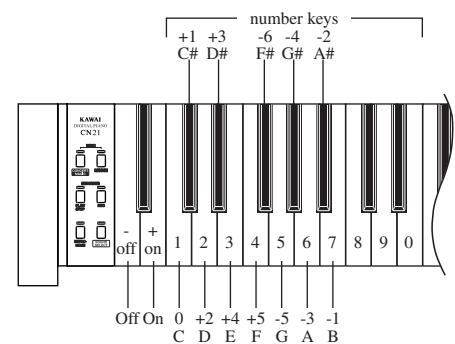

The CN21 piano can be transposed up to 5 half steps higher (F) or 6 half steps lower (F#).

The transpose value is set to 0 (C) when the CN21 piano is turned on.

■ The transpose function can be turned off/on, retaining the set value, by using the '-' (off) or '+' (on) keys.

4) TUNING

The TUNING function allows the piano's pitch to be finely adjusted, and may prove useful when playing with other instruments.

The factory default value is set to the modern standard A = 440.0 Hz and can be adjusted in 0.5 Hz increments.

□ Step 1

Press and hold the METRONOME and SOUND SELECT buttons at the same time, then press the key assigned to the TUNING function.

A tuning tone will be played.

□ Step 2

While still holding down the METRONOME and SOUND SELECT buttons, press the '-' (off) or '+' (on) keys to lower or raise the tuning pitch by 0.5 Hz, or enter the desired tuning pitch as a three digit number using the number keys.

- For example, to set the tuning pitch to A = 441.5 Hz, first press the keys '4', '4', and '1', then press the '+' (on) key. Alternatively, first press the keys '4', '4', and '2', then press the '-' (off) key.

5) REVERB

The REVERB function adds reverberation to the sound, simulating the acoustic environment of a recital room, stage, or concert hall. There are three types of reverb available: Room, Stage and Hall.

The most suitable reverb setting is applied to each sound type automatically.

□ Step 1

Press and hold the METRONOME and SOUND SELECT buttons at the same time, then press the key assigned to the REVERB function.

□ Step 2

While still holding down the METRONOME and SOUND SELECT buttons, press one of the following keys to select the Reverb type:

- Key 1: ROOM
- Key 2: STAGE
- Key 3: HALL

- The reverberation sound increases in length as the setting is changed from ROOM -> STAGE -> HALL.
- The reverberation function will be turned on upon selecting a reverb type.

The REVERB function is automatically activated when the CN21 piano is turned on.

□ Step 3

To turn on/off the REVERB function, press and hold the METRONOME and SOUND SELECT buttons at the same time, press the key assigned to the REVERB function, and then press the '+' (on) or '-' (off) key.

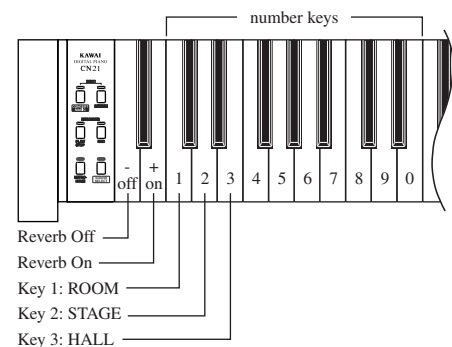

6) CONCERT MAGIC MODE

The CN21 piano offers two ways to enjoy Concert Magic.

◆ Mode 1

Mode 1 categorises each of the 44 Concert Magic songs into one of three different arrangement types, depending on the skill level required to perform them. They are Easy Beat, Melody Play and Skillful. See page 17 for details.

◆ Mode 2

Mode 2 allows Concert Magic songs to be played by simply tapping any key with a constant steady beat, regardless of the song arrangement type.

□ Step 1

Press and hold the METRONOME and SOUND SELECT buttons at the same time, then press the key assigned to the CONCERT MAGIC MODE function.

□ Step 2

While still holding down the METRONOME and SOUND SELECT buttons, press the '+' (on) key to set Concert Magic Mode to Mode 2, or the '-' (off) key to set Concert Magic Mode to Mode 1.

The Concert Magic Mode is set to Mode 1 when the CN21 piano is turned on.

7) MIDI CHANNEL SELECT

◇ About MIDI

The term MIDI is an acronym for Musical Instrument Digital Interface, an international standard for connecting synthesizers, sequencers (MIDI recorders) and other electronic instruments so that they can exchange performance data. The CN21 is equipped with two MIDI jacks for exchanging data: MIDI IN and MIDI OUT. Each uses a special cable with a DIN connector.

- MIDI IN : For receiving note, program change and other data.
- MIDI OUT : For sending note, program change and other data.

■ Connection to an external sequencer

When connected to an external sequencer, songs played on the CN21 piano can be recorded using a MIDI recorder, with preset sounds (such as piano, harpsichord and vibraphone, etc.) controlled by the CN21's MULTITIMBRAL MODE function to create a multi-layered MIDI recording.

◇ CN21 MIDI functions

· Transmit / receive keyboard note information	· Receive volume data
· Transmit / receive channel setting	· Multi-timbral setting
· Transmit / receive Program change (sound type) number	· Transmit / receive exclusive data
· Transmit / receive pedal data	

In order to exchange MIDI information with another MIDI instrument, the two connected instruments must be set to the same channel.

Step 1

Press and hold the METRONOME and SOUND SELECT buttons at the same time, then press the key assigned to the MIDI CH function.

Step 2

While still holding down the METRONOME and SOUND SELECT buttons, select the desired MIDI channel by entering a two digit number using the number keys.

- For example, to set the MIDI channel to CH 1, press the '0' key and then the '1' key.
To set the MIDI channel to CH 16, press the '1' key and then the '6' key.
- A MIDI channel can be set within the range of 1 to 16.
- The MIDI channel is automatically set to CH 1 when the CN21 piano is turned on.

8) MIDI LOCAL CONTROL ON/OFF

This function is used to control whether or not the sound from the CN21 piano will be heard when playing the keyboard. When MIDI LOCAL CONTROL is set to 'on', sound will be heard when playing the CN21 piano's keyboard. When MIDI LOCAL CONTROL is set to 'off', sound will not be heard when playing the CN21 piano's keyboard, however the keyboard data will still be transmitted to an external MIDI device.

When MIDI information is received, the sound will be played through the CN21 piano.

Step 1

Press and hold the METRONOME and SOUND SELECT buttons at the same time, then press the key assigned to the LOCAL function.

Step 2

While still holding down the METRONOME and SOUND SELECT buttons, press the key '-' (off) to set MIDI LOCAL CONTROL to 'off', or the '+' (on) key to set MIDI LOCAL CONTROL to 'on'.

- The MIDI Local Control setting is automatically set to 'on' when the CN21 piano is turned on.

9) TURNING MULTI-TIMBRAL MODE ON/OFF

The procedure described in the MIDI CHANNEL SELECT section is used to transmit or receive data on only one of the 16 MIDI channels (CH 1 - CH 16). However, by enabling MULTI-TIMBRAL MODE, MIDI data can be received on more than one MIDI channel, simultaneously playing a different sound on each channel. With this feature enabled, an external sequencer can be used to enjoy ensemble performances, playing multiple sound types on a single CN21 piano.

The term 'Multi-Timbral' is derived from the ability to play multiple timbres simultaneously.

- Please refer to the chart below for information regarding received program numbers and the corresponding sound types.
- Data received through CH 10 will not be performed when MULTI-TIMBRAL MODE is enabled.

□ Step 1

Press and hold the METRONOME and SOUND SELECT buttons at the same time, then press the key assigned to the MULTI function.

□ Step 2

While still holding down the METRONOME and SOUND SELECT buttons, press the key '-' (off) to set MULTI-TIMBRAL MODE to 'off', or the '+' (on) key to set MULTI-TIMBRAL MODE to 'on'.

- The MULTI-TIMBRAL MODE setting is automatically set to 'off' when the CN21 piano is turned on.

■ Program Change Number Mapping

Sound Name	Multi-Timbral mode ON			Multi-Timbral mode OFF
	Program #	Bank MSB	Bank LSB	
CONCERT GRAND	1	121	0	1
STUDIO GRAND	1	121	1	2
MODERN PIANO	2	121	0	3
ROCK PIANO	2	121	1	4
CLASSIC E.PIANO	5	121	0	5
MODERN E.P.	6	121	0	6
JAZZ ORGAN	18	121	0	7
CHURCH ORGAN	20	121	0	8
HARPSICHORD	7	121	0	9
VIBRAPHONE	12	121	0	10
STRING ENSEMBLE	49	121	0	11
SLOW STRINGS	45	95	1	12
CHOIR	53	121	0	13
NEW AGE PAD	89	121	0	14
ATMOSPHERE	100	121	0	15

10) TRANSMIT MIDI PROGRAM CHANGE

This function determines whether or not the CN21 piano will transmit program change information when sound types are changes. It is also possible to transmit a program change number (ranging from 1 to 128) in order to change the sound type of an external MIDI sound source.

□ Step 1

Press and hold the METRONOME and SOUND SELECT buttons at the same time, then press the key assigned to the PROGRAM function.

□ Step 2

While still holding down the METRONOME and SOUND SELECT buttons, press the '-'(off)' key to disable transmitting program change data when selecting sounds, or the '+' (on)' key to enable transmitting program change data when selecting sounds.

■ The TRANSMIT PROGRAM CHANGE setting is set to 'off' when the CN21 piano is turned on.

□ Step 3

To transmit the desired program change number directly, first press and hold the METRONOME and SOUND SELECT buttons at the same time, press the key assigned to the PROGRAM function, then enter the three digit number using the lowest 15 number keys.

■ Three digit program change numbers ranging from 001 to 128 can be transmitted. For example, press '0', '0', and '1' to transmit program change number 1.

■ The program change number will be transmitted as soon as the key for the third digit number is pressed.

Use these keys to specify the program change number to be transmitted.

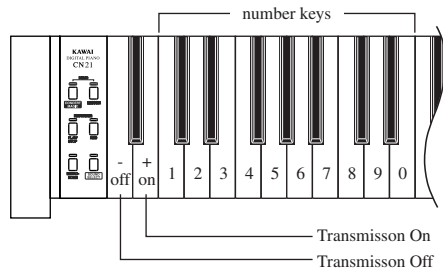

6. APPENDICES

1) CONNECTING TO OTHER DECVICES

*The digital piano viewed from below.

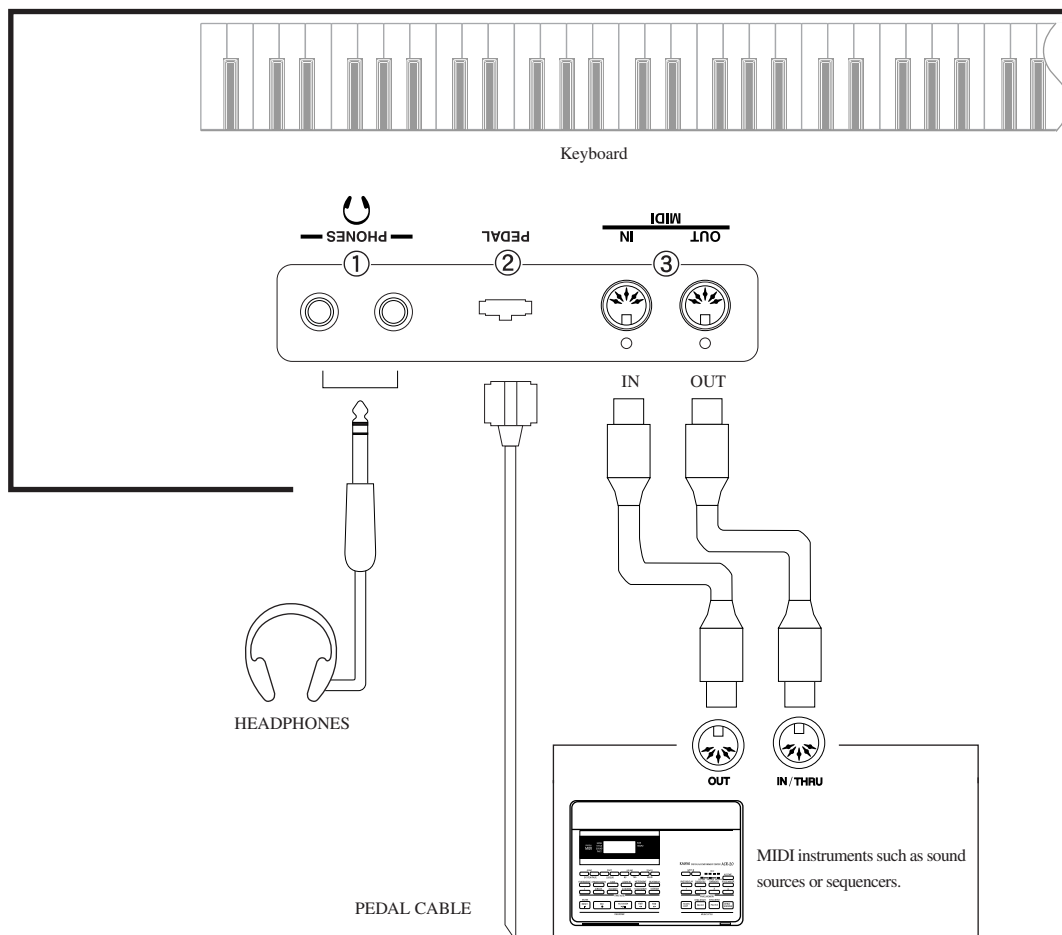

① HEADPHONE JACKS

Used to connect up to two pairs of headphones to the CN21 piano.

② PEDAL JACK

Used to connect the pedal board to the CN21 piano.

③ MIDI JACKS

Used to connect the CN21 piano with external MIDI devices.

2) ASSEMBLY INSTRUCTIONS

- ⚠ Caution**
- Ensure that this section is read thoroughly before attempting to assemble the CN21 piano, and that two or more people work on unit assembly.
 - When moving the CN21 piano, ensure that hands are not caught in the unit, and that the piano is not dropped on an individual's feet.

Before attempting to assemble the CN21 piano, ensure that all parts are included.
A Phillips-head screwdriver will also be required to assemble the unit (not included).

■ PARTS PROVIDED

Side Panel (A).....	2pcs.
Back Panel (B).....	1 pc.
Pedal Board (C).....	1 pc.
Screw (D).....	2 pcs.
Screw (E).....	4 pcs.
Bolt (F).....	4 pcs.
Bolt (with plain washers and spring washers) (F').....	4 pcs.
Adjuster (G).....	1 pc.
Headphone hook set	
· Headphone hook.....	1 pc.
· Tapping screw.....	2 pcs.

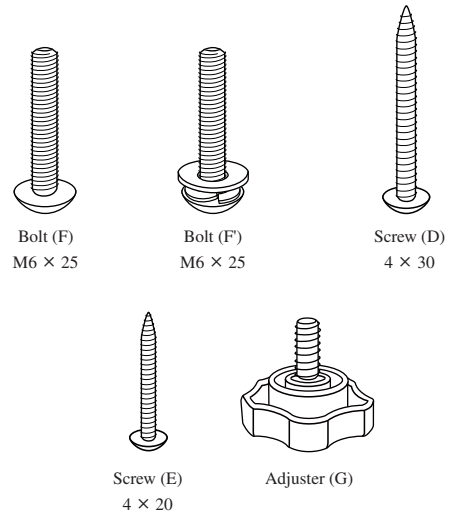

■ ASSEMBLY SEQUENCE

1. Insert the Adjuster (G) on the bottom of Pedal Board (C).
Untie the connection cord from the Pedal Board and pull it out.
Fasten Side Panel (A) and Pedal Board (C) with four bolts (F).
Ensure that the bolts are fastened tightly.
Use the correct side panel for the left side and the right side of the unit.
Ensure that the pedal cable is not caught between the assembled parts.

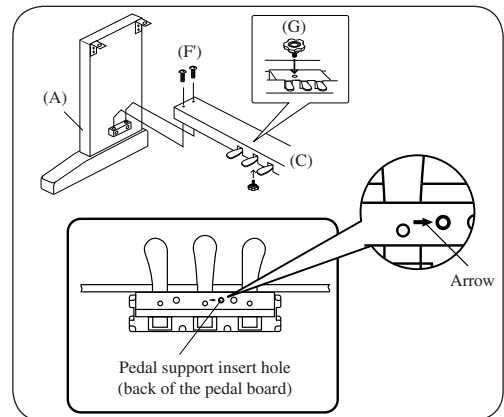

2. Fasten Side Panel (A) and Back Panel (B) with two screws (D).
Then fix Back Panel (B) to Pedal Board (C) with four screws (E).

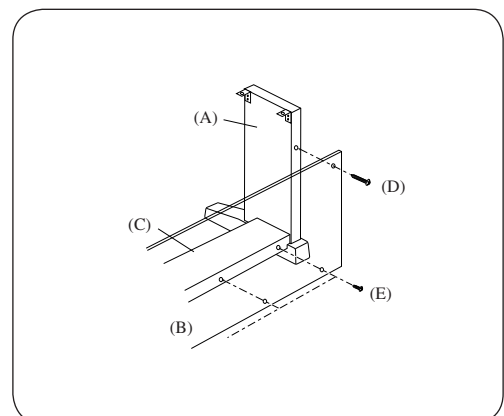

3. Place the piano on the front half of the stand so that the metal fitting holes are seen when viewed from the top. Slide the piano backward while holding it with one hand so that it does not incline and fall from the stand. The hooks on the piano are then engaged with the metal fittings on the Side Panels. Pay attention so that hands or fingers are not caught between the stand and piano. Fasten the piano and the stand with four bolts (with plain washers and spring washers)(F'). First, loosely tighten the bolts to adjust the unit position in order to make sure that all four bolts can be inserted straight. Then, tighten the bolts. Make sure that the bolts are tightened until the spring washers collapse.

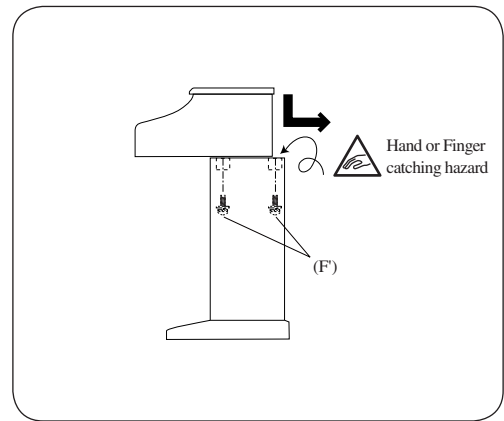

Caution • Ensure that the CN21 piano is correctly secured to the stand by using the bolts included. Failing to do so may result in the unit falling from the stand, causing damage or personal injury.

4. Insert the pedal connection cord that comes from Pedal Board (C) into the piano's pedal jack and fasten with cord clamps.

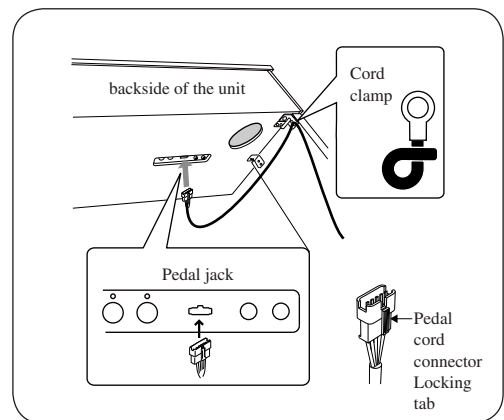

5. Fix the headphone hook to the location marked with red ink by using two tapping screws provided in the same plastic bag.

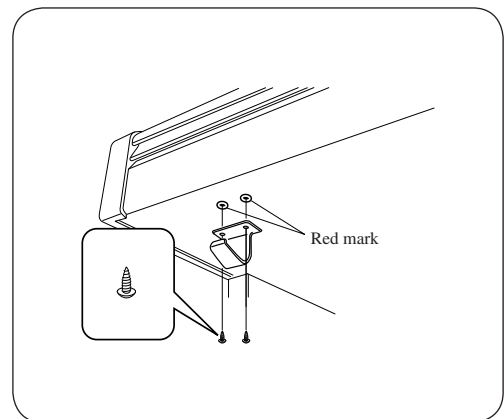

6. Turn the Adjuster (installed on the bottom of C) until it touches the floor to support the pedal board.

Caution • The pedal board may break if the adjuster is not touching the floor correctly. When moving the CN21 piano, ensure that the the unit is lifted clearly from the floor and not dragged.

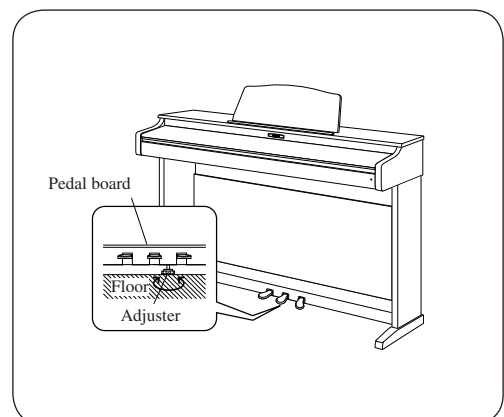

3) CONCERT MAGIC SONG LIST

Category	Song Name	Key	Mode
Children's Songs	Twinkle, Twinkle, Little Star	1	MP
	I'm A Little Teapot	2	MP
	Mary Had A Little Lamb	3	MP
	London Bridge	4	MP
	Row, Row, Row, Your Boat	5	MP
	Frère Jacques	6	MP
	Old MacDonald Had A Farm	7	MP
Christmas Songs	Hark The Herald Angels Sing	8	MP
	Jingle Bells	9	Mp
	Deck The Halls	10	MP
	O Come All Ye Faithful	11	MP
	Joy To The World	12	MP
	Silent Night	13	MP
	We Wish You A Merry Christmas	14	MP
American Classics	Battle Hymn Of The Republic	15	MP
	Yankee Doodle	16	MP
	Danny Boy	17	EB
	Clementine	18	MP
	Auld Lang Syne	19	MP
	Oh Susanna	20	SK
	The Camptown Races	21	MP
	When The Saints Go Marching In	22	EB
	The Entertainer	23	SK
Classical Selections	William Tell Overture	24	SK
	Andante from Symphony No.94 (Haydn)	25	MP
	Für Elise	26	EB
	Clair De Lune	27	SK
	Skater's Waltz	28	SK
	Blue Danube Waltz	29	SK
	Gavotte (Gossec)	30	SK
	Waltz of The Flowers	31	SK
Specail Occations	Bridal Chorus	32	MP
	Wedding March	33	SK
	Pomp And Circumstance	34	SK
International Songs	When Irish Eyes Are Smiling	35	EB
	Chiapenecas	36	SK
	Santa Lucia	37	SK
	Funiculi Funicula	38	SK
	Romance De L'amour	39	EB
	My Wild Irish Rose	40	EB

4) LESSON SONG LIST

◇ ALFRED'S BASIC PIANO LIBRARY

Alfred's Basic Piano Library lesson book is sold separately. Please check with local dealers or contact Alfred's customer service by telephoning 818-892-2452 (USA & Canada), 0-95240033 (Australia), +44 (0) 279828960 (UK). Or alternatively, by e-mailing customerservice@alfred.com.

Basic Piano Library Lesson Book Level 1A

1. Right & Left
2. Left & Right
3. Merrily We Roll Along/O'er the Deep Blue Sea
4. Hand-Bells
5. Jolly Old Saint Nicholas
6. Old MacDonald
7. Batter Up!
8. My Clever Pup
9. The Zoo
10. Playing in a New Position
11. Sailing
12. Skating
13. Wishing Well
14. Rain, Rain!
15. A Happy Song
16. Position C
17. A Happy Song
18. See-Saws
19. Just a Second!
20. Balloons
21. Who's on Third?
22. Mexican Hat Dance
23. Rock Song
24. Rockets
25. Sea Divers
26. Play a Fourth
27. July the Fourth!
28. Old Uncle Bill
29. Love Somebody
30. My Fifth
31. The Donkey
32. Position G
33. Jingle Bells!
34. Willie & Tillie
35. A Friend Like YouG
36. My Robot
37. Rockin' Tune
38. Indian Song
39. Raindrops
40. It' s Halloween!
41. Horse Sense

Basic Piano Library Lesson Book Level 1B

1. Step Right Up!
2. The Carousel
3. Hail to Thee, America!
4. Brother John
5. Good Sounds
6. The Cuckoo
7. Money Can' t Buy Ev' rything!
8. Ping-Pong
9. Granpa' s Clock
10. When the Saints Go Marching In
11. G' s in the "BAG"
12. Join the Fun
13. Oom-Pa-pa!
14. The Clown
15. Thumbs on C!
16. Waltz Time
17. Good King Wenceslas
18. The Rainbow
19. Good Morning to You!
20. Happy Birthday to You!
21. Yankee Doodle
22. The Windmill
23. Indians
24. New Position G
25. Pedal Play
26. Harp Song
27. Concert Time
28. Music Box Rock
29. A Cowboy' s Song
30. The Magic Man
31. The Greatest Show on Earth
32. The Whirlwind
33. The Planets
34. C Major Scale Piece
35. G Major Scale Piece
36. Carol in G Major
37. The Same Carol in C Major
38. French Lullaby
39. Sonatina
40. When Our Band Goes Marching By!

◇ BURGMÜLLER & CZERNY ETUDES

**BURGMÜLLER 25
(25 ETUDES FACILES, OPUS 100)**

1. La candeur
2. Arabesque
3. Pastorale
4. Petite réunion
5. Innocence
6. Progrès
7. Courant limpide
8. La gracieuse
9. La chasse
10. Tendre fleur
11. La bergeronnette
12. Adieu
13. Consolation
14. La styrienne
15. Ballade
16. Douce plainte
17. Babillarde
18. Inquiétude
19. Ave Maria
20. Tarentelle
21. Harmonie des anges
22. Barcarolle
23. Retour
24. L'hirondelle
25. La chevaleresque

CZERNY 30 (ETUDES DE MÉCANISME, OPUS 849)

* No song names

5) SPECIFICATIONS

■ Keyboard	88 Weighted Keys with Advanced Hammer Action IV
■ Max Polyphony	96 notes
■ Tones	15 Tones (Concert Grand, Studio Grand, Modern Piano, Rock Piano, Classic E.Piano, Modern E.P., Jazz Organ, Church Organ, Harpsichord, Vibraphone, String Ensemble, Slow Strings, Choir, New Age Pad, Atmosphere)
■ Other Functions	Volume, Transpose, Tuning, Dual, Demo (15 Songs), Touch Type (Normal, Light, Heavy, Constant), Reverb (Room, Stage, Hall), Concert Magic (40 Songs), MIDI Functions
■ Lesson	2 song books (Please refer to Appendix 4), right/left part separately playable, tempo adjustable
■ Recorder	The total memory capacity of the recorder is approximately 7,500 notes (1 song, 1 track)
■ Metronome	Beat: 1/4, 2/4, 3/4, 4/4, 5/4, 3/8, 6/8, Tempo: 10-300 BPM
■ Pedals	Sustain (half-pedalling supported), Soft, Sostenuato
■ Jacks	Headphones x 2, Pedal, MIDI IN/OUT
■ Output Power	16 W x 2
■ Speakers	12 cm x 2
■ Key cover	Slide type
■ Power Consumption	50 W
■ Dimensions	137 (W) x 42.5 (D) x 84 (H) cm (without Music Rack)
■ Weight	43.5 kg

6) MIDI IMPLEMENTATION CHART

KAWAI DIGITATL PIANO
MODEL : CN21

Date : November 2006
Version : 1. 0

FUNCTION		TRANSMITTED	RECEIVED	REMARKS
Basic channel	(Default) (Changed)	1 1 - 16	1 1 - 16	
Mode	(Default) (Message) (Altered)	3 × *****	1 1, 3* ×	* The default for the OMNI mode is ON. Specifying MIDI channels automatically turns it OFF.
Note number	(True Voice)	15 - 113* *****	0 - 127 15 - 113	* with Transpose
Velocity	(Note ON) (Note OFF)	○ 9nH v=1-127 × 8nH v=0	○ ×	
After touch	Key's Channel's	× ×	× ×	
Pitch Bend		×	×	
Control change	7 64 66 67	× ○ ○ ○	○ ○ ○ ○	Volume Sustain pedal Sostenute pedal Soft pedal
Program Change	True	○ *****	○	See the Program Change Number Mapping on page 29.
System Exclusive		○	○	
Common	(Song Position) (Song Select) (Tune)	× × ×	× × ×	
System :	(Clock) Real time (Commands)	× ×	× ×	
Other	(Local ON / OFF) (All Notes OFF) (Active Sense) (Reset)	× × ○ ×	○ ○* ○* ×	* When Multi-Timbral mode is ON

Mode 1 : OMNI ON, POLY Mode 2 : OMNI ON, MONO
Mode 3 : OMNI OFF, POLY Mode 4 : OMNI OFF, MONO

○: Yes
×: No

KAWAI

THE FUTURE OF THE PIANO

CN21 Owner's Manual
KPSZ-0142 : 815660
OW1003E-S0711
Version.2
Printed in Indonesia

Copyright © 2007 KAWAI Musical Instruments Mfg. Co.,Ltd. All Rights Reserved.