

KAWAI

Digital Piano

CA9

CA7

Owner's Manual

Important Safety Instructions

SAVE THESE INSTRUCTIONS

INSTRUCTIONS PERTAINING TO A RISK OF FIRE, ELECTRIC SHOCK, OR INJURY TO PERSONS



WARNING

TO REDUCE THE RISK OF FIRE OR ELECTRIC SHOCK, DO NOT EXPOSE THIS PRODUCT TO RAIN OR MOISTURE.

AVIS : RISQUE DE CHOC ELECTRIQUE - NE PAS OUVRIR.

TO REDUCE THE RISK OF ELECTRIC SHOCK, DO NOT REMOVE COVER (OR BACK).
NO USER-SERVICEABLE PARTS INSIDE. REFER SERVICING TO QUALIFIED SERVICE PERSONNEL.



The lightning flash with arrowhead symbol, within an equilateral triangle, is intended to alert the user to the presence of uninsulated "dangerous voltage" within the product's enclosure that may be of sufficient magnitude to constitute a risk of electric shock to persons.



The exclamation point within an equilateral triangle is intended to alert the user to the presence of important operating and maintenance (servicing) instructions in the literature accompanying the product.

Examples of Picture Symbols



denotes that care should be taken.
The example instructs the user to take care not to allow fingers to be trapped.



denotes a prohibited operation.
The example instructs that disassembly of the product is prohibited.



denotes an operation that should be carried out.
The example instructs the user to remove the power cord plug from the AC outlet.

Read all the instructions before using the product.

WARNING - When using electric products, basic precautions should always be followed, including the following.



WARNING Indicates a potential hazard that could result in death or serious injury if the product is handled incorrectly.

The product should be connected to an AC outlet of the specified voltage.



- If you are going to use an AC power cord, make sure that it has the correct plug shape and conforms to the specified power voltage.
- Failure to do so may result in fire.

Do not insert or disconnect the power cord plug with wet hands.



Doing so may cause electric shock.

The chair must be used properly (it must be used only when playing the product).

- Do not play with it or stand on it.
- Only one person is allowed to sit on it.
- Do not sit on it when opening the lid.

Doing so may cause the chair to fall over or your fingers to be trapped, resulting in injury.

When using the headphones, do not listen for long periods of time at high volume levels.



Doing so may result in hearing problems.

Do not lean against the keyboard.

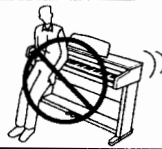

Doing so may cause the product to fall over, resulting in injury.

Do not disassemble, repair or modify the product.



Doing so may result in product breakdown, electric shock or short-circuit.

When disconnecting the AC power cord's plug, always hold the plug and pull it to remove it.



● Pulling the AC power cord itself may damage the cord, causing a fire, electric shock or short-circuit.

The product is not completely disconnected from the power supply even when the power switch is turned off. If the product will not be used for a long time, unplug the AC power cord from the AC outlet.



● Failure to do so may cause fire in case of lightning.
● Failure to do so may over-heat the product, resulting in fire.

This product may be equipped with a polarized line plug (one blade wider than the other). This is a safety feature. If you are unable to insert the plug into the outlet, contact an electrician to replace your obsolete outlet. Do not defeat the safety purpose of the plug.

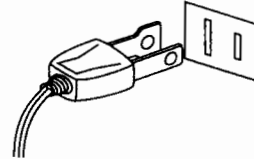

CAUTION

Indicates a potential hazard that could result in injury or damage to the product or other

Do not use the product in the following areas.

- Areas, such as those near windows, where the product is exposed to direct sunlight
- Extremely hot areas, such as near a heater
- Extremely cold areas, such as outside
- Extremely humid areas
- Areas where a large amount of sand or dust is present
- Areas where the product is exposed to excessive vibrations

Using the product in such areas may result in product breakdown.

When you close the keyboard cover, close it gently.

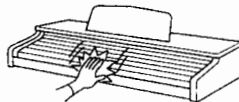

Closing it roughly may trap your fingers, resulting in injury.

Before connecting cords, make sure that the power to this product and other devices is turned OFF.

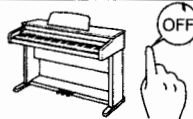

Failure to do so may cause breakdown of this product and other devices.

Take care not to allow any foreign matter to enter the product.

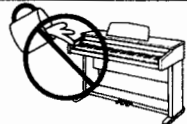

Entry of water, needles or hair pins may result in breakdown or short-circuit. The product shall not be exposed to dripping or splashing. No objects filled with liquids, such as vases, shall be placed on the product.

Do not drag the product on the floor. Take care not to drop the product.

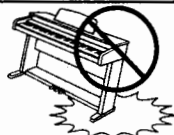

Please lift up the product when moving it. Please note that the product is heavy and must be carried by more than two persons. Dropping the product may result in breakdown.

Do not place the product near electrical appliances such as TVs and radios.

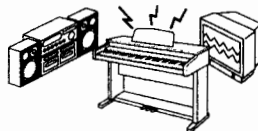

● Doing so may cause the product to generate noise.
● If the product generates noise, move the product sufficiently away from the electrical appliance or connect it to another AC outlet.

When connecting the AC power cord and other cords, take care not to get them tangled.



Failure to do so may damage them, resulting in fire, electric shock or short-circuit.

Do not wipe the product with benzene or thinner.



- Doing so may result in discoloration or deformation of the product.
- When cleaning the product, put a soft cloth in lukewarm water, squeeze it well, then wipe the product.

Do not stand on the product or exert excessive force.



- Doing so may cause the product to become deformed or fall over, resulting in breakdown or injury.

The product should be located so that its location or position does not interfere with its proper ventilation.

This product should be used only with the stand that is provided by the manufacturer.

The product should be serviced by qualified service personnel when:

- The power supply cord or the plug has been damaged.
- Objects have fallen, or liquid has been spilled into the product.
- The product has been exposed to rain.
- The product does not appear to operate normally or exhibits a marked change in performance.
- The product has been dropped, or the enclosure damaged.

Notes on Repair

Should an abnormality occur in the product, immediately turn the power OFF, disconnect the power cord plug, and then contact the shop from which the product was purchased.

CAUTION:

To prevent electric shock, match wide blade of plug to wide slot, fully insert.

ATTENTION:

Pour éviter les chocs électriques, introduire la lame la plus large de la fiche dans la borne correspondante de la prise et pousser jusqu'au fond.

Instruction for AC power cord (U.K.)

Do not plug either terminal of the power cord to the ground of the AC outlet on the wall.

FCC Information

This equipment has been tested and found to comply with the limits for a Class B digital device, pursuant to Part 15 of the FCC Rules. These limits are designed to provide reasonable protection against harmful interference in a residential installation. This equipment generates, uses and can radiate radio frequency energy and, if not installed and used in accordance with the instructions, may cause harmful interference to radio communications.

If this equipment does cause harmful interference to radio or television reception, which can be determined by turning the equipment off and on, the user is encouraged to try to correct the interference by one or more of the following measures:

- Reorient or relocate the receiving antenna.
- Increase the separation between the equipment and receiver.
- Connect the equipment into an outlet on a different electrical circuit from the receiver.
- Consult the dealer or an experienced radio/TV technician for help.

Canadian Radio Interference Regulations

This instrument complies with the limits for a class B digital apparatus, pursuant to the Radio Interference Regulations, C.R.C., c. 1374.

THANK YOU FOR PURCHASING A KAWAI DIGITAL PIANO!

The Kawai digital piano is a revolutionary new keyboard instrument that combines the latest in electronic advances with traditional craftsmanship inherited from Kawai's many years of experience in building fine pianos. Its keyboard provides the touch response and full dynamic range required for a superb performance on the piano, harpsichord, organ, and other instruments. In addition, the CA piano is equipped with reverb and a digital effect processor for an even fuller sound. Industry-Standard MIDI (Musical Instrument Digital Interface) jacks are included which allow you to play other electronic instruments at the same time—opening a whole new world of musical possibilities.

This Owner's Manual contains valuable information that will help you make full use of this instrument's many capabilities. Please read all sections carefully and keep this manual handy for further reference.

READ ME FIRST (CA7)

Before beginning the assembly of your CA7 read and become familiar with the assembly instructions that follow. Then, carefully unpack the piano and check your unit against the parts list.

PARTS PROVIDED

Side Panel (A)	2 pcs.
Back Board (B)	1 pc.
Pedal Board (C)	1 pc.
Speaker Cover (D)	1 pc.
Screw E (M6 x 25)	8 pcs.
Screw F (M4 x 12)	8 pcs.
Screw G (ø4 x 20)	4 pcs.
Adjuster (H)	1 pc.
Headphone Hook	1 pc.

M6 x 25

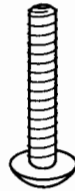

(E)

M4 x 12

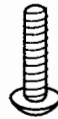

(F)

ø4 x 20

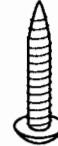

(G)

Adjuster

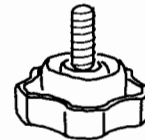

(H)

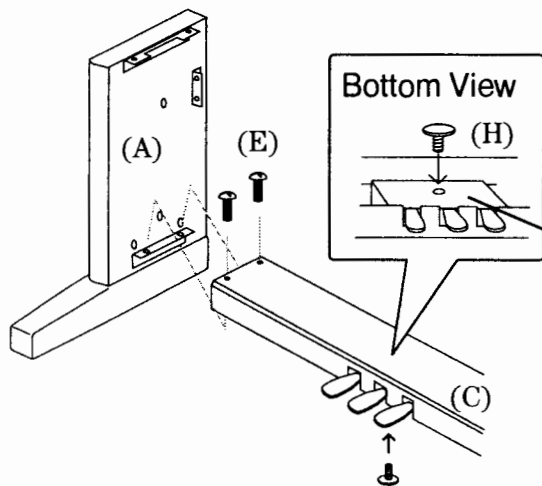

1. Insert the Adjuster (H) on the Pedal Unit.
2. Untie the pedal cable on the bottom of the Pedal Board (C).
3. Fasten the Side Panels (A) and the Pedal Board (C) with four screws (E).

Pedal Unit

4. Hold the Back Board (B) behind the Pedal Board (C) and in front of the fixing metal of the Side Panels (A).
5. Fasten the Side Panels (A) and Back Board (B) with four screws (F).
6. Fasten the Pedal Board (C) and Back Board (B) with four screws (G).

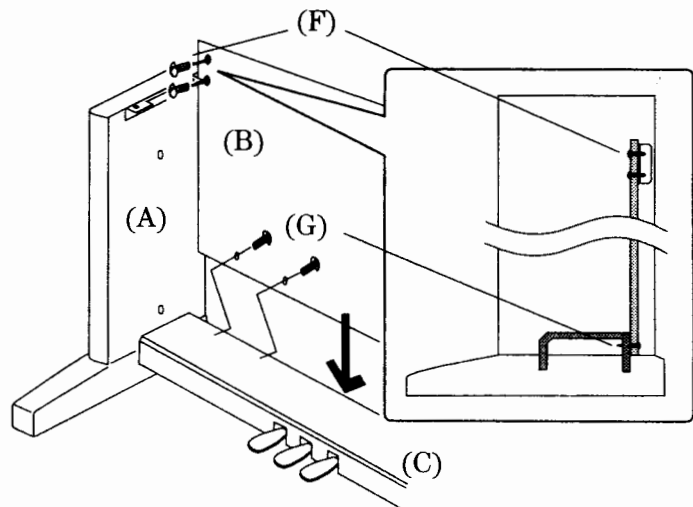

CAUTION:

To prevent personal injury, do not handle the main unit from the ends.

7. The next step requires one person on each end of the main unit. Grasp the unit with both hands, one under the front, the other under the rear (remember, not the end) and carefully center the main unit on top of the stand so that the hook brackets located on the bottom rear of the main unit are inside the stand side panels (A) and approximately one-third of the rear, top edge of the side panels are exposed. (See the illustration to the right)

8. Maintaining a firm grasp under the front of the main unit slide it toward the rear of the stand until the hook brackets engage the brackets at the rear top of the side panels (A). This hook arrangement is design to prevent the main unit from tilting forward while the screws are installed. Keep one hand under the front of the main unit, push down on the front to be certain that hooks are properly engaged.

9. Fasten the main unit and the stand with four screws (E).

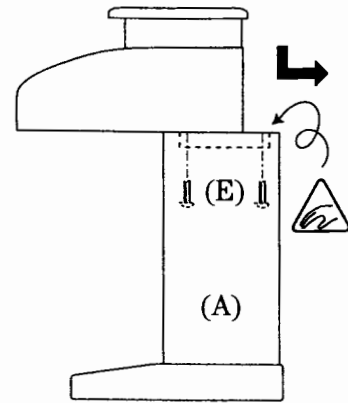

CAUTION:

Be sure to secure the main unit to the stand with the screws. If you fail to do so, the unit could fall from the stand causing damage or personal injury.

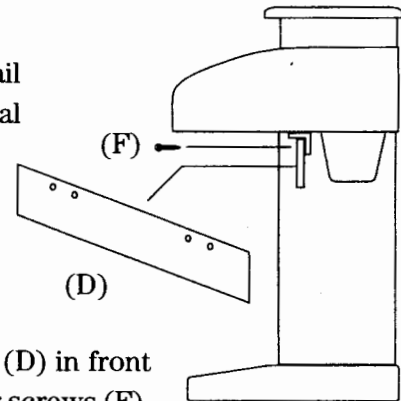

10. Attach the Speaker Cover (D) in front of the speaker boxes with four screws (F).

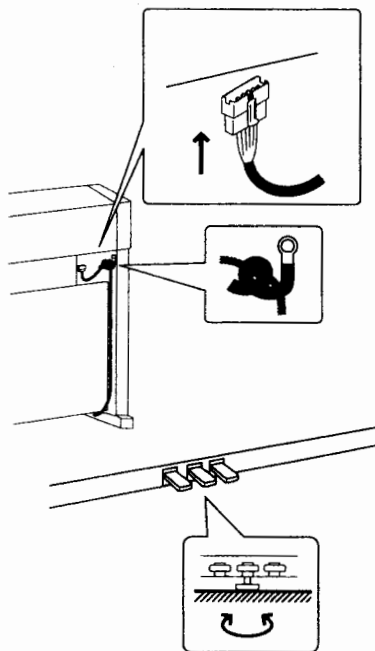

11. Insert the pedal connection cord that comes from Pedal Board into the main unit's pedal jack and fix with the clamp of the Side Panel.

12. Turn the adjuster (installed on the bottom of the Pedal Unit) down until it makes firm contact with the floor. If the floor is carpeted, place a spiked furniture cup under the adjuster so that it makes firm contact with the carpet backing. Press any pedal with your foot. If the pedal rail flexes, lower the adjuster until flexing is minimized.

CAUTION:

Before moving your piano, turn the adjuster up so that it clears the floor.

READ ME FIRST (CA9)

Before beginning the assembly of your CA9 read and become familiar with the assembly instructions that follow. Then, carefully unpack the piano and check your unit against the parts list.

PARTS PROVIDED

End Panel (A)	2 pcs.	Screw H (M6 x 25)	8 pcs.
Side Panel (B)	2 pcs.	Screw I (M4 x 20)	10 pcs.
Back Board (C)	1 pc.	Screw J (ø4 x 20)	4 pcs.
Front Panel (D)	1 pc.	Screw K (ø4 x 12)	1 pc.
Pedal Board (E)	1 pc.	Cord Clamp (L)	1 pc.
Speaker Box (F)	2 pcs.	Adjuster (M)	1 pc.
Screw G (M6 x 40)	8 pcs.	Spring Washer	4 pcs.
		Plain Washer	4 pcs.

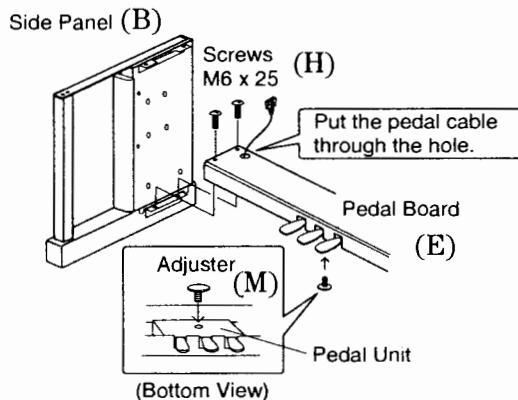
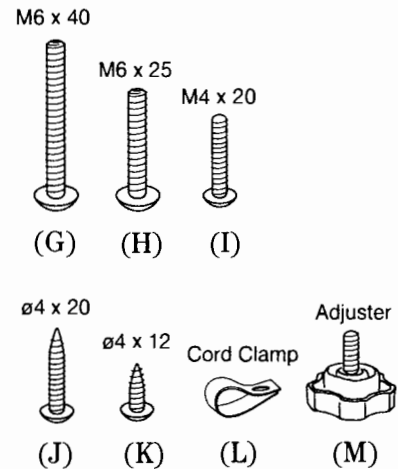

1. Insert the Adjuster (M) on the Pedal Unit.
2. Untie the pedal cable on the bottom of the Pedal Board (E) and put it through the hole of the Pedal Board (E).
3. Fasten the Side Panels (B) and the Pedal Board (E) a little loosely with the four screws (H). Put the four screws through the spring washer and plain washer in advance.

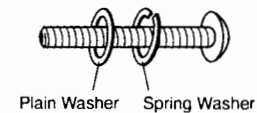

4. Put the Front Panel (D) on the Pedal Board (E) from the front. Fit the Front Panel (D) into the grooves on the Side Panels (B).
5. Fasten the four screws (H) on the Pedal Board (E) again firmly. Then fasten the Front Panel (D) and the Side Panel (B) and the Pedal Board (E) with six screws (I).

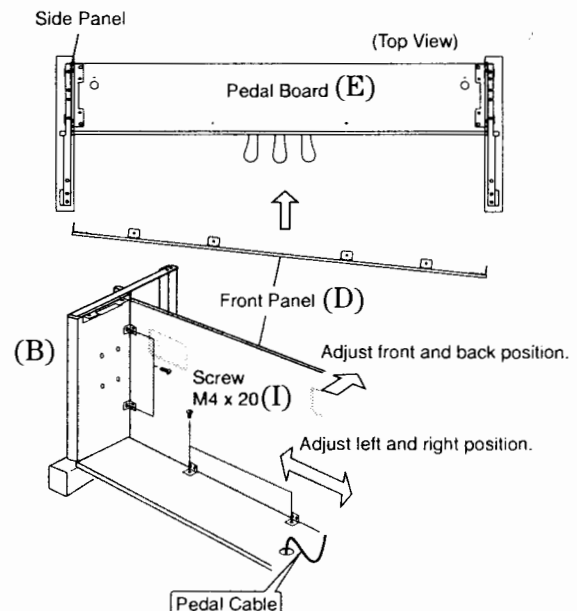

6. The next step requires one person on each end of the main unit. Grasp the unit with both hands, one under the front, the other under the rear (remember, not the end) and carefully center the main unit on top of the stand so that the hook brackets located on the bottom rear of the main unit are inside the stand side panels (B) and approximately one-third of the rear, top edge of the side panels are exposed. (See the illustration to the right)

7. Maintaining a firm grasp under the front of the main unit slide it toward the rear of the stand until the hook brackets engage the brackets at the rear top of the side panels (B). This hook arrangement is design to prevent the main unit from tilting forward while the screws are installed. Keep one hand under the front of the main unit, push down on the front to be certain that hooks are properly engaged.

8. Fasten the main unit and the stand with six screws (H). Adjust the position of the main unit so that the face A and B become straight.

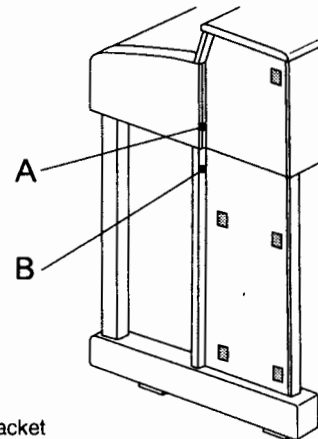
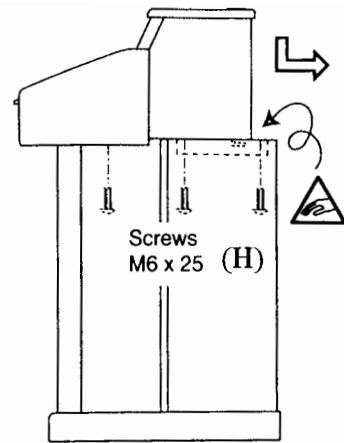

CAUTION:

Be sure to secure the main unit to the stand with the screws. If you fail to do so, the unit could fall from the stand causing damage or personal injury.

9. Put the right speaker box (the one with two connectors) on the bracket of the Front Panel and align the screw holes to the holes of the right Side Panel (B). Fasten with the four screws (G).

10. Repeat the same for the left speaker box.

11. Connect the both speaker cables together and then connect to the speaker cable connector of the main unit.

12. Put the pedal cable to the pedal cable connector of the main unit.

13. Attach the speaker cables and pedal cable with vinyl binders as illustrated.

14. Connect the power cable to the power cable connector of the main unit. Put it through the hole of the pedal board and fix with Cord Clamp (L) and screw (K) at the pedal board near the hole. Turn the cord around the Cord Clamp as illustrated.

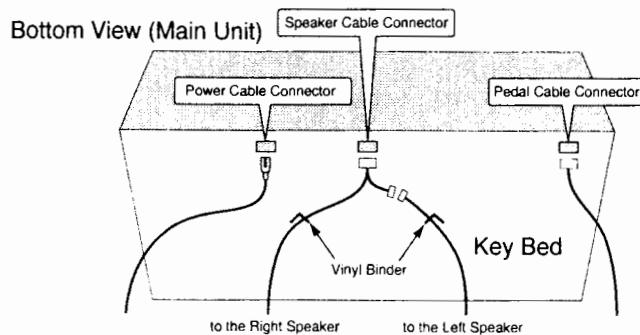
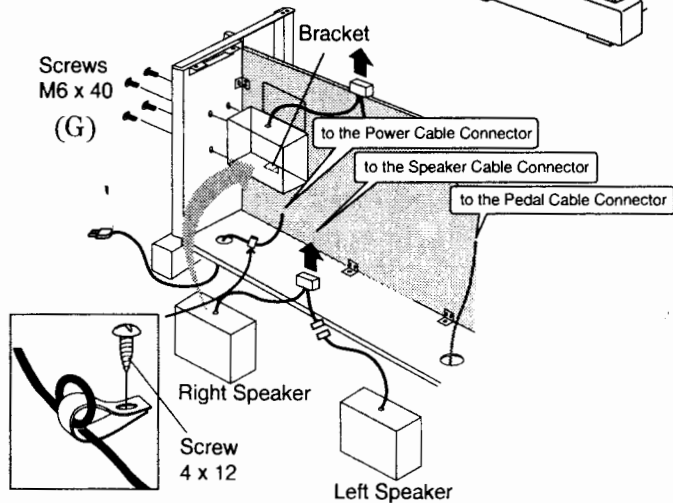

ASSEMBLING THE MUSIC RACK

1. Place the music rack a little right side of the center of the piano. Push the music rack forward slightly.
2. Slide the music rack to the left and it will be locked at the center of the piano.

* When disassembling the music rack, bring it slightly up and slide it to the right.

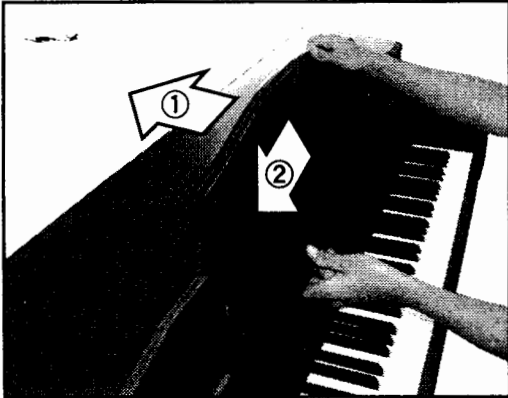

ATTACHING THE HEADPHONE HOOK

1. Attach the headphone hook with two screws (M4 x 12) to the holes next to the headphone jacks.

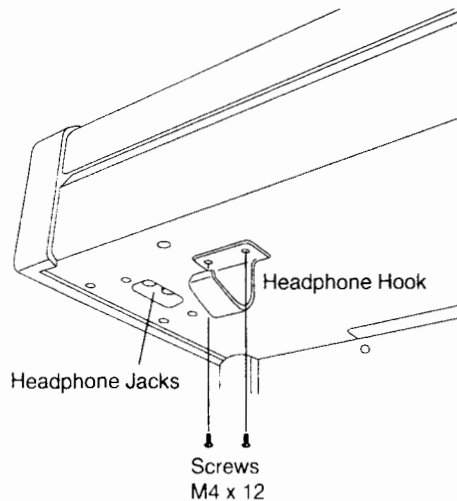

1. Quick Start

p. 10

1.1 SETTING UP THE PIANO	10
1.2 POWER SWITCH	10
1.3 VOLUME SLIDER	10
1.4 HEADPHONES	10
1.5 DEMO SONGS	11
1.6 PIANO MUSIC BUTTONS	11
1.7 PLAYING THE PIANO	12
1.8 PEDALS	12
1.9 PLAYING WITH MORE SOUNDS	13

2. Advanced Playing

p. 14

2.1 VALUE BUTTONS	14
2.2 DUAL	14
2.3 SPLIT	14
2.4 DUAL/SPLIT BALANCE SLIDER	15
2.5 REGISTRATION BUTTONS	15
2.6 EFFECTS/REVERB	16
2.7 TRANSPOSE	18
2.8 METRONOME/RHYTHM	19

3. Recorder

p. 22

BASICS OF THE RECORDER	22
3.1 RECORDING (REC BUTTON)	23
3.2 PLAYING BACK A SONG (PLAY/STOP BUTTON)	25
3.3 ERASING A SONG	26

4. Playing with the Concert Magic

p. 28

4.1 SELECTING A SONG	28
4.2 LISTENING TO THE SONG	28
4.3 PERFORMING A SONG	29
4.4 PART VOLUME BALANCE FOR CONCERT MAGIC	30
4.5 CONCERT MAGIC SONG ARRANGEMENT TYPES	30
4.6 STEADY BEAT	32
4.7 CONCERT MAGIC SONG DEMO	32
4.8 ADJUSTING THE PLAYBACK SPEED FOR THE CONCERT MAGIC SONGS	33

5. Virtual Technician and Menu Functions

p. 34

5.1 VIRTUAL TECHNICIAN BUTTON	34
VOICING	35
DAMPER EFFECT	35
STRING RESONANCE	36
TOUCH	36
TEMPERAMENT	37
KEY OF TEMPERAMENT	40
STRETCH TUNING	40
PIANO AMBIENCE	40
5.2 MENU BUTTONS	41
BRILLIANCE	42
LOWER OCTAVE SHIFT	42
LOWER PEDAL ON/OFF	42
LAYER OCTAVE SHIFT	42
LAYER DYNAMICS	43
DAMPER HOLD	43
TUNING	44
MIDI CHANNEL	44
SENDING PROGRAM CHANGE NUMBERS	44
LOCAL CONTROL ON/OFF	45
TRANSMIT PROGRAM CHANGE ON/OFF	45
MULTI-TIMBRAL MODE	45
CHANNEL MUTE	46
USER MEMORY	46
FACTORY RESET	47

6. Using MIDI

p. 48

UNDERSTANDING MIDI	48
6.1 USING THE CA PIANO AS CONTROLLER	50
6.2 USING THE CA PIANO AS A MULTI-TIMBRAL SOUND MODULE	53

7. Jacks

p. 56

LINE OUT JACKS	56
LINE IN JACKS	56
MIDI JACKS	56
USB JACK	56
HEADPHONE JACKS	56
NOTES ABOUT USB	57

8. Appendices

p. 58



1. QUICK START

1.1 SETTING UP THE PIANO

The first thing you'll need to do before playing the piano is to set up the instrument.

ASSEMBLING THE STAND

First, you need to assemble the stand unit. Assemble the stand following the instructions at the beginning of this manual.

SUPPLYING AC POWER

The CA piano is equipped with stereo speakers and an amplifier. You do not need any other equipment to play your piano. You can enjoy the CA piano wherever AC power is available. Simply connect the power cable that comes with the CA piano to an AC outlet.

Connect the AC power cable to the piano's power jack and the other end of the cable to the AC outlet on the wall.

1.2 POWER SWITCH



**Press this button to turn on the power.
Pressing it again will turn off the power.**

Pressing this button while holding down the REC and PLAY/STOP buttons will erase all the songs currently stored in the Recorder. (See page 27.)

Pressing this button while holding down the TRANSPOSE and VIRTUAL TECHNICIAN buttons will reset the Registration to the factory settings. (See page 16.)

1.3 VOLUME SLIDER

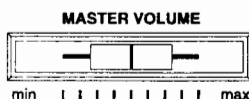

This slider controls the master volume level of the piano's sound.

Move this slider to the right to increase the volume and move to the left to decrease the volume.

This slider also controls the headphone's volume and the LINE output level of the piano's sound.

1.4 HEADPHONES

For private performances you may want to use the headphones. The speakers will be turned off automatically when the headphones are plugged in, and the CA piano will only be heard through the headphones. The CA piano has two headphones jacks.

1.5 DEMO SONGS



The CA9 has 32 built-in sound demo songs (30 for CA7). Each of the demo songs presents a musical piece to introduce the different preset sounds.

Press the DEMO button and the demo song for the Piano 1 category will start. After the Piano 1 demo songs are finished playing, the demo songs for another sound category will be selected at random.

If you would like to listen to the demos for a particular category, just press the desired SOUND SELECT button while the demo is playing. When you press the button, the demo will play the demo songs for the newly selected category. Then the demo songs for another category will be selected at random. See page 65 for the list of sound demo songs.

1.6 PIANO MUSIC BUTTONS

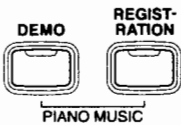

Pressing the DEMO button and the REGISTRATION button together lets you enter the Piano Music mode. The CA piano provides over two hours of pre-recorded Classical piano music for your listening pleasure.

Press the DEMO button and the REGISTRATION button together. The LEDs for both buttons will be turned on and the LCD display will show the current song title.

Use the VALUE buttons to select your desired song.

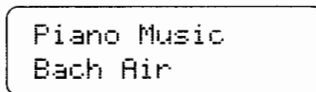

The LCD display shows the song name.

◆ NOTE

See page 64 for Piano Music song list.

Press the START/STOP button. The selected song will be played. When the song finishes, the CA piano will select another song randomly and continue playing. You can also change the song with VALUE buttons.

Press the START/STOP button again to stop playing.

To exit the Piano Music mode, press the DEMO button and the REGISTRATION button together.

1.7 PLAYING THE PIANO

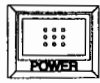

Turning on the power.

You will find the POWER SWITCH at the right end of the front panel. Press this button to turn on the power. Pressing it again will turn off the power.

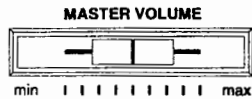

Adjust the volume level.

The VOLUME SLIDER controls the volume level of the speakers and the headphones. Use this slider to set the volume to a comfortable listening level.

Now try playing the keyboard.

You will hear the CA's main piano sound. The name of the sound "Concert Grand" is shown in the LCD Display.

Concert Grand

The CA piano responds just like a real acoustic piano when you play it. It produces a louder sound when you play hard and a softer sound when you play soft. The volume level changes in relation to how fast the keys are pressed. This system is called "**touch sensitivity**" on an electronic musical instrument. The initial touch sensitivity setting has been adjusted to the standard of an acoustic piano. You can however, select a different type of touch sensitivity on the CA piano if you are not comfortable with the standard setting. For more detail, please read "**4. Touch**" on page 36.

1.8 PEDALS

The CA piano has three pedals—just like a grand piano. They are Sustain, Soft and Sostenuto.

The sustain pedal is capable of responding to half pedaling, which provides even finer control of the dampening effect.

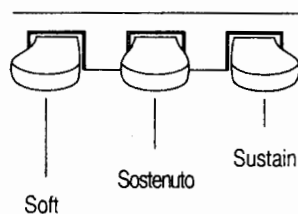

1.9 PLAYING WITH MORE SOUNDS

You have already heard the CA's main piano sound. The CA9 has a total of 80 sounds (60 for the CA7), not only different types of piano sounds but different instruments as well.

The different instrument sounds built into CA piano are called “**preset sounds**”.

All of the preset sounds have been created through advanced digital sampling technology achieving as natural and realistic sound as possible. Let's try some of the preset sounds.

SELECTING ANOTHER PRESET SOUND

Press the **SOUND SELECT** button under the name of the instrument you would like to listen to. When the button is pressed, the LED indicator will be turned on to indicate that this sound is selected.

The name of the selected preset sound is also shown in the LCD Display.

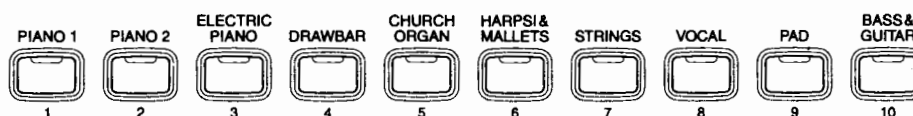

The **SOUND SELECT** buttons are assigned with six (CA7) or eight (CA9) preset sounds to select. **To select the other sounds, press the button repeatedly.**

You can also select any preset sounds by using the **VALUE** buttons.

2. ADVANCED PLAYING

2.1 VALUE BUTTONS

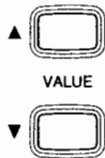

These two buttons are used to change the value for certain functions.

First select the function or option you would like to change the value for by pressing the appropriate button(s), then use the VALUE buttons to change the value. “▲” button increases the value and “▼” decreases the value.

These buttons can also be used to select the various sounds. You can select all of the preset sounds assigned to the ten SOUND SELECT buttons.

However, Sounds cannot be selected by using the Value buttons when you are in DUAL or SPLIT mode.

2.2 DUAL

Another feature of the CA piano is the ability to layer two preset sounds together to create a more complex sound. For example, piano layered with strings, electric piano with choir sound, and so on.

To layer two sounds, press the SOUND SELECT buttons for both sounds simultaneously. The LED indicators for each will be turned on to indicate the two sounds you have chosen. You will find the selected sound names are also shown in the LCD display.

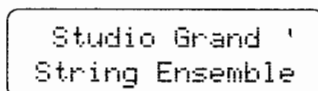

Both sound names are displayed.

If you want to layer two sounds assigned to the same SOUND SELECT button, while pressing the desired SOUND SELECT button use the VALUE buttons to select your desired layered sound.

ABOUT POLYPHONY

The CA piano is capable of playing up to 96 notes simultaneously (96-note polyphony). When playing in dual mode, or when playing the stereo piano sound, the polyphony will be reduced by half since the piano has to produce two sounds for each note.

2.3 SPLIT



SELECTING SPLIT SOUNDS

The split function divides the keyboard into two sections—upper and lower—and lets you play each part with a different sound.

First press the desired **SOUND SELECT** button to select the upper sound. Then, while holding down the **SPLIT** button, press the desired **SOUND SELECT** button to select the lower sound. The **LED Indicator** for the upper sound will be turned on and the **LED** for the lower sound will start flashing.

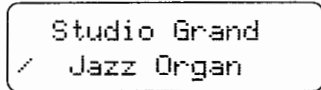

The LCD Display shows you which sounds are selected for the upper and lower sections.

CHANGING THE SPLIT POINT

The default split point is set between B2 and C3. This point can be moved to anywhere on the keyboard.

Press the desired key while holding down the SPLIT button.

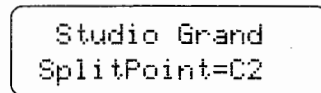

The LCD Display shows you which key you pressed

The key you pressed becomes the lowermost note for the upper section.

2.4 DUAL/SPLIT BALANCE SLIDER



You can adjust the volume balance between the two sounds in Dual or Split mode. **Use the Dual/Split Balance slider to adjust the balance.** Move the slider to the right to increase the volume of the rightmost sound (in dual mode) or upper sound (in split mode) and decrease the volume of the leftmost sound (in dual mode) or lower sound (in split mode). The balance changes in the opposite way when the slider is moved to the left.

2.5 REGISTRATION BUTTON



A Registration is a setup that remembers most of the panel settings, such as sound selections and effect settings, so that you can recall them at the touch of a button. 10 Registrations can be memorized and saved.

MEMORIZING A REGISTRATION

To memorize the current panel settings, press and hold the **REGISTRATION** button until the sound button LEDs start blinking and the LCD displays the message “To save Regist Press 1-10”.

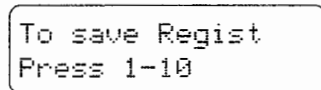

The LCD display shows the Save Registration screen.

Press any one of the sound buttons marked 1 through 10 to select a location for your new Registration.

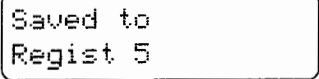

Saved to
Regist 5

The LCD display shows the registration was saved to sound button number 5.

A beep sound confirms that your Registration has now been saved to your selected location.

RECALLING A REGISTRATION

To recall a registration, first press the REGISTRATION button and make sure its LED is turned on. Then press one of the Sound buttons marked 1 through 10 to select the desired registration.

RESETTING THE REGISTRATIONS

To reset all of the registration settings to the factory preset values, first turn the power off. Then turn it on again while holding down the TRANSPOSE and VIRTUAL TECHNICIAN buttons.

◆ NOTE

A registration can memorize the settings listed below.

- Sound selection
- Dual/Split mode, Dual/Split Balance, Split point
- Effect/Reverb settings
- Touch Curve setting
- Voicing setting
- Damper Effect setting
- String Resonance setting
- Damper Hold setting
- Temperament settings
- Brilliance setting
- Lower Octave Shift setting
- Lower Pedal setting
- Layer Octave Shift setting
- Layer Dynamics setting
- Tuning
- Stretch Tuning
- Piano Ambience setting

2.6 EFFECTS/REVERB

You might have noticed that when you select some of the preset sounds, the LED indicator for the EFFECTS or the REVERB is turned on. The reason for this is some of the preset sounds are set up with an effect on as their initial setting.

Adding an effect to the sound enhances tonal quality and improves acoustical realism. The CA piano is provided with two separate groups

of effects. The first is reverb and the second contains chorus, delay, tremolo and rotary speaker.

REVERB

Reverb adds reverberation to the sound, simulating the acoustic environment of a recital room, stage, or concert hall. There are five types of reverb available. They are Room 1&2, Stage, and Hall 1&2. (listed in order of reverberation amount).

CHORUS

Chorus is an effect that simulates the rich character of a vocal choir or string ensemble, by layering a slightly detuned version of the sound over the original to enrich it.

DELAY

Delay is an effect that adds echoes to the sound. There are three types of delay available (delay 1 - 3), each of which has a different length of delay between the echoes.

TREMOLO

This is a vibrato type effect.

ROTARY

This effect simulates the sound of the Rotary Speaker cabinet commonly used with electronic organs. Rotary 1 is normal rotary and Rotary 2 is with distortion effect.

The soft pedal is used to change the speed of the rotor between SLOW and FAST.

TO ADD REVERB

Press the REVERB button. The LED indicator will be turned on to indicate that reverb is in use. Press and hold the REVERB button and the currently selected reverb type will be shown in the LCD display.

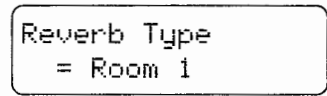

The LCD Display shows the currently selected reverb.

To change the reverb type, use the VALUE buttons.



TO ADD OTHER EFFECTS

Press the EFFECTS button. The LED indicator will be turned on to indicate that the effect is in use. Press and hold the EFFECTS button and the currently selected effect will be shown in the LCD display.

Effect Type
= Chorus

The LCD Display shows the currently selected effect.

To change the effect type, use the VALUE buttons.

In addition to changing the effect type you can also edit some of the effect settings for each effect type.

To edit the effect settings, press the MENU buttons. The LCD display shows the editable effect setting and its value. Use the Value buttons to change the value.

Press the MENU buttons again to select the next editable effect setting for that effect type.

Chorus Depth
= 5

The LCD Display shows Chorus Depth value.

To turn off the reverb or effects, press the REVERB or EFFECTS button again.

◆ NOTE

Any changes you make to the reverb and the effects are stored with the preset sound in memory as long as the power is on. When you reselect a sound, your chosen reverb and effect settings will be recalled along with the preset sound.

When the power is turned off the effects will be reset to the factory settings unless you use the "User Memory" function to save your current reverb and effect settings.

For more information about the "User Memory" function please see page 46 in this manual.

2.7 TRANSPOSE



The transpose function lets you raise or lower the piano's key in half steps. This is especially useful when you have learned a song in one key and have to play it in another key. The transpose feature allows you to play the song in the original key, but hear it in another key.

Press and hold the TRANSPOSE button.

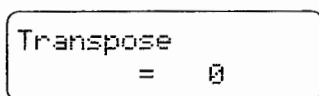

The LCD display shows you the current value. The value is always set to "0" when the power is turned on.

While still holding the TRANSPOSE button, use the VALUE buttons or the keyboard from C2 to C4 to specify the transposition amount.

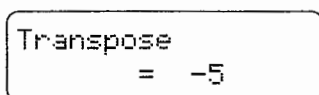

The LCD display shows you a number telling you how many half steps up or down you have transposed the piano. -5, for example, represents a transposition that is 5 half steps lower. "0" indicates no transposition.

The piano can be transposed up to 12 half steps higher or 12 half steps lower.

Pressing TRANSPOSE button again turns the TRANSPOSE function off.

The TRANSPOSE function remembers the current setting as long as the power is on.

2.8 METRONOME/RHYTHM

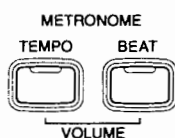

Rhythm is one of the most important elements when learning music. It is important to practice playing the piano at the correct tempo and with a steady rhythm. The CA piano's metronome is a tool that helps you to achieve this by providing a steady beat for you play along with.

STARTING THE METRONOME

Press the TEMPO button. You will see the LED indicator turn on and hear the metronome begin counting with a steady beat. The LCD display shows the tempo in beats per minute.

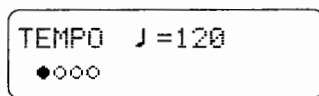

Tempo is displayed in number of beats per minute.

To change the tempo, use the VALUE buttons to increase or decrease the tempo within the range of 30 - 300 beats per minute. (60-600 BPM with eighth note rhythms).

To stop the metronome, press the TEMPO button again.

CHANGING THE TIME SIGNATURE

You probably noticed that there are two types of clicks and the louder one comes every fourth beat. The metronome is capable of giving you a down beat to indicate the beginning of the measure. You are now hearing a 4-beat or 4/4 time signature.

You can select a different time signature, if you want to. There are nine different time signatures available on the CA piano—1/4, 2/4, 3/4, 4/4, 5/4, 3/8, 6/8, 7/8, 9/8 and 12/8. You can also select one of the 100 built-in rhythm styles instead of a simple metronome click.

To change the time signature, use the BEAT button.

Press the BEAT button. You will see the LED indicator turn on and hear the metronome begin counting. The LCD display shows the time signature and a visual indicator of beats per measure.

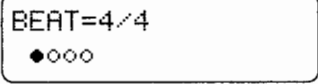

BEAT=4/4
●○○○

The selected time signature is displayed along with a visual indicator of beats per measure.

Use the VALUE buttons to select your desired time signature. You will see the time signature currently selected in the LCD display. The visual indicator will change to match the selected time signature.

RHYTHM METRONOME

You can also select from 100 additional rhythm styles instead of a simple metronome click.

Keep pressing the VALUE buttons to select the desired rhythm style number. See page 61 for the rhythm style list.

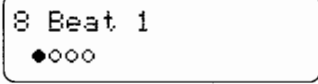

8 Beat 1
●○○○

The selected Rhythm Style is displayed.

To stop the metronome, press the BEAT button again.

You can use either the TEMPO or BEAT button to turn the metronome on and off. Choose the appropriate button depending on whether you're adjusting the tempo or changing the time signature.

ADJUSTING THE METRONOME VOLUME

The volume level of metronome can be adjusted to any level you like independent of the main volume.

Press the **TEMPO** and **BEAT** buttons simultaneously. The LCD displays the volume level of the metronome in numbers from 1 (soft) to 10 (loud). The factory preset is 5.

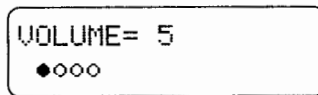

The volume level is displayed.

Use the **VALUE** buttons to change value.

◆ **NOTE**

All the metronome settings will be reset to the factory preset values after turning off the power unless you use the “User Memory” function to save your current metronome settings.

For more information about the “User Memory” function please see page 46 in this manual.

3. RECORDER

The CA piano's recorder records your playing much like a tape recorder, and it is just as easy to use. The CA piano records a song as digital data instead of audio data and stores the song inside the instrument. Because the song is stored as digital information you can modify the song when you play it back. You can, for example, adjust the tempo without changing the pitch or use a different effect setting from one you have recorded.

Once you understand the recorder, you will find it to be a useful tool for both practicing and playing the piano.

BASICS OF THE RECORDER

Let's take a brief look at the recorder's features.

TWO-TRACK FIVE-SONG RECORDER

The CA piano's recorder is a **2-track 5-song recorder**. This means you can record up to five different songs, store them in memory, and play them back as you like.

Each song has two separate tracks called "**Parts**" that can be recorded separately. This lets you record for example, the left hand part first on one track, then record the right hand part next on the other track while listening to the first track.

When you record or play back a song, you can select which part (track) of which song you are going to record or play back. When you are recording, selecting the same part again to record will erase any previous recordings on that part. Because of this it's important to remember; when recording both parts separately, after recording the first part be sure to select the second part to record, otherwise you will end up recording over the first part of the song.

RECORDED INFORMATION

The CA piano records the following:

Note information

Sound selection

Pedal movements

Balance settings Set the dual/split balance as desired before you start recording. Balance settings made before you start recording will be used by the recorder. Any changes made during the recording will be ignored by the recorder.

Transpose When you record in a different key using the transpose function, the CA piano will record the actual transposed notes you hear, not the notes as you play with the keyboard.

RECORDING CAPACITY

The total recording capacity is about 15,000 notes. Pressing any buttons or pedals is counted as one note.

When the recorder reaches its maximum capacity, the CA piano will stop recording at that point.

RECORDER AND METRONOME

When playing back a song with the metronome turned on, the metronome always restarts with the down beat.

3.1 RECORDING (REC BUTTON)

The REC button is used for recording.

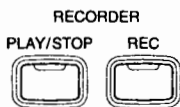

Press the REC button when you are ready to record. The LED indicator will start flashing telling you that the piano is ready to record.

Record
SONG 1 Part=1

The LCD Display shows the Song and Part number to be recorded.

Now play some music on the piano. The recorder will automatically start recording with the first note you play.

Press the PLAY/STOP button when you are finished recording. The piano will stop recording and save your song to memory.

Saving to memory may take a few moments and during this time the piano will not perform any other operations.

You can start recording by pressing the PLAY/STOP button instead of pressing a key. In this way, you can insert a blank bar at the beginning of the song.

If you make a mistake, you can record your piece again. Just repeat the same procedure. The second recording will completely erase the first one.

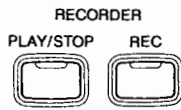

RECORDING ANOTHER SONG

The CA piano is capable of recording and storing up to five different songs. Let's try recording a second song.

If you followed the procedure in the previous section you have already recorded Song 1, so now let's record Song 2.

Press the REC button to enter the song/part selection menu. Use the MENU buttons to change the song number to Song 2.

```
Record
SONG 2 Part=1
```

The LCD display shows the song number and part number to be recorded.

When you are ready to record, just start playing the keyboard.

The CA piano will start recording automatically with the first note you play.

Press the PLAY/STOP button when you are finished recording.

RECORDING A SECOND PART

You can record a second part in the second track (part) of the same song. After recording the first part, select the other track and record your second part.

Press the REC button to enter the song/part selection menu.

```
Record
SONG 3 Part=1
```

The LCD display shows the song number and part number to be recorded.

Use the MENU buttons to select song 3 .

Record the first part just the same as in the previous sections and press the PLAY/STOP button when you're finished recording.

Now press the REC button to enter the song/part menu then select Part 2 to record. Use the VALUE buttons to select part 2.

```
Record
SONG 3 Part=2
```

The LCD display shows the song and part number to record.

If you want to start recording the second part from the beginning of the song, **just play the keyboard**. You will hear the first part playing back while you record the second part.

If you would like to play back the first part and then start recording the second part from a certain point later in the song, press the PLAY/STOP button instead of playing the keyboard to start playback of the first part and then begin recording the second part from any point you like.

When you are finished recording, press the PLAY/STOP button again.

STATUS OF SONG AND PART

In the LCD display an asterisk (*) after the part number means that the part has been already recorded.

```
Record
SONG 3 Part=2*
```

"" indicates that this part has already been recorded.*

3.2 PLAYING BACK A SONG (PLAY/STOP BUTTON)

The PLAY/STOP button is used to select a song and part to play, and to start and stop play back of the recorded songs.

Press the PLAY/STOP button one time to select a specific song and part you would like to play back. Use the MENU buttons to select a song and use the VALUE buttons to select a part.

```
Select SONG/PART
SONG 1 Part=1&2*
```

The LCD Display shows that both parts of song 1 are selected to play back

Press the PLAY/STOP button again and the recorded song will start playing.

```
Playing
SONG 1 Part=1&2*
```

The LCD Display shows that the selected song is playing.

Press the PLAY/STOP button again to stop play back and return to the song select display.

PLAYING BACK THE PARTS SEPARATELY

While you are in the palyback menu, use the VALUE buttons to select the desired part number you want to listen to.

```
Playing
SONG 3 Part=2*
```

An asterisk indicates that the part has been recorded.

You can select between, "Part 1", "Part 2", and "Part 1&2". To check that you have recorded on both tracks, select "Part 1", then select "Part 2".

You will see an asterisk after each part, this means you have successfully recorded both parts.

To listen to both parts together select “Part 1&2”.

To play back an individual part, select the desired part using the VALUE button first, then press the PLAY/STOP button to listen.

◆ NOTE

If you don't see an asterisk after each part you recorded or if your song does not play back correctly, carefully reread the previous section on recording to make sure you're recording properly. You can use the LCD display to help determine if you have a problem.

USING THE PLAY/STOP BUTTON TO START RECORDING

The PLAY/STOP button can also be used to start recording. In this way, you can insert a blank bar at the beginning of the song.

Press the REC button to enable the piano to record first, then press the PLAY/STOP button. On pressing the PLAY/STOP button, the CA piano starts recording regardless of whether you press a key or not.

3.3 ERASING A SONG

This function allows you to erase any song you do not want to listen to.

To erase a specific song or part, first press both the REC and PLAY/STOP button. The LCD display will display the erase menu where you select a song or a part to erase.

```
To Del Press REC
SONG 1 Part=1&2*
```

Select the song and the part to erase.

Use the MENU buttons to select the desired song, and use the VALUE buttons to select the desired part to erase.

Press the REC button to erase. The LCD display will ask you if you're sure.

```
Sure? Press REC
SONG 1 Part=1&2*
```

Confirmation to erase the song.

If you are sure you want to erase the song and part, press the REC button again.

If you want to cancel the erase procedure, press the PLAY/STOP button.

Delete Completed
SONG 1 Part=1&2

The erase procedure is completed.

ERASING ALL THE SONGS

To erase all the songs at once, first turn off the power then turn it back on again while holding down both the REC and PLAY/STOP buttons.

Recorder



4. PLAYING WITH CONCERT MAGIC

The great German composer Johann Sebastian Bach once said, "Playing the keyboard is simple. Just strike the right keys at the right time." Many people wish it were that simple. The reality is very different of course. However, there is a way to make playing the keyboard very simple. You don't even have to strike the right keys thanks to Concert Magic.

With CONCERT MAGIC, absolutely anyone can sit at the CA piano and make real music... even if you've never taken a piano lesson in your life. To enjoy performing by yourself, you have only to select your favorite piece from 176 preprogrammed songs and tap any of the 88 piano keys with a steady rhythm and tempo. CONCERT MAGIC will provide the correct melody and accompaniment notes, regardless of which keys you press. Anybody, young or old, can enjoy CONCERT MAGIC from the moment they sit down at the CA piano. Now let's see how CONCERT MAGIC works.

Playing with
Concert Magic

4.1 SELECTING A SONG

The 176 Concert Magic songs are assigned to each of the 88 piano keys, two songs for each key. There are two banks of songs, Bank A and Bank B. Each bank contains 88 songs.

The songs are also classified in eight groups by song category such as Children's Songs, American Classics, Christmas Songs.

All of the song titles are listed on page 62 in the appendices section of this manual. To make it easier to find which song is assigned to which key, there is a key strip that can be placed between the end of black keys and the front panel. The key strip indicates song categories, and note names.



To select a song, press the key to which your desired song is assigned while holding down the CONCERT MAGIC button.

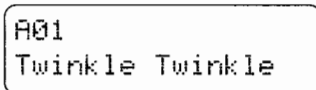

The LCD display shows you the song number and abbreviated song title.

You have selected a song in Bank A. **To select a song in Bank B, press the same key again.** The LCD display shows you another song title with "B" at the beginning. Repeatedly pressing the key switches between the two banks.

4.2 LISTENING TO THE SONG

If you have selected a song you are familiar with, you may want to play by yourself right away. However you may want to listen to the song first before playing it.

To listen, press the PLAY/STOP button. The CA piano will start playing back the selected song. You can adjust the speed or tempo of the song by using the VALUE buttons while holding down the TEMPO button. While you are listening you can select a different Concert Magic song by using the VALUE buttons.

You probably noticed that the circles in the LCD display turn into smaller plus signs as the song is played back. This is called the Note Navigator. These circles and plus signs provide a visual guide that shows you when to press the next key. The space between the circles and position of the circles in the LCD shows you the approximate timing between each key press.

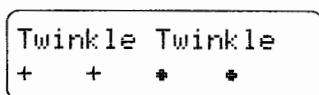

The circles turn into small plus signs as the song is playing.

The key to performing using Concert Magic is to know the rhythm of the song. The Note Navigator provides a rough outline of the songs rhythm, that will help you to learn the song's rhythm and then perform it by yourself.

If you want to listen to a different song, press the key to which your desired song is assigned while holding down the CONCERT MAGIC button. To listen, press the PLAY/STOP button.

When you are finished listening to the song, **press the PLAY/STOP button again to stop.**

4.3 PERFORMING A SONG

Now you're ready to play yourself.

Tap out the rhythm of the selected song on any one of the 88 black or white keys on the piano's keyboard.

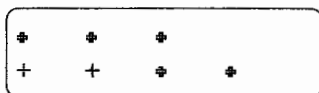

Use the Note Navigator (the circles and plus signs) to learn the rhythm of the Concert Magic song.

As you tap harder, the notes will get louder; as you tap softer, the notes will get quieter. As you tap faster, the notes speed up; as you tap slower, they will slow down correspondingly, just like regular piano playing. Isn't it fun? You can sound like you've been playing for years just by pressing one key with one finger.

Concert Magic is a perfect method for small children to learn music, especially to develop a sense of rhythm. For older people who may think it is too late to learn the keyboard, Concert Magic is a good first step for them to begin with. With Concert Magic, your CA piano can be enjoyed by anyone in the family, even those who have never touched a musical instrument in their life.

4.4 PART VOLUME BALANCE FOR CONCERT MAGIC

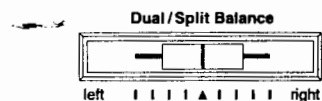

When used with Concert Magic, the balance slider adjusts the volume balance of the melody part and the accompaniment.

As the slider is moved to the right, the sound of the melody becomes louder and the accompaniment becomes softer. The balance changes in the opposite way when the slider is moved to the left.

4.5 CONCERT MAGIC SONG ARRANGEMENT TYPES

After playing for a while with Concert Magic you may think that it's too easy and there is very little to learn.

While it is true that some of the songs are very easy to play, even for beginners, there are also some which will challenge you and require practice to play beautifully. Each of the 176 Concert Magic songs falls into one of three different arrangement types depending on the skill level required to perform them.

EASY BEAT

These are the easiest songs to play. To perform them, simply tap out a constant steady beat on any key on the keyboard.

Look at the following example, "Für Elise". The Note Navigator indicates that you should keep a constant steady rhythm all the way through the song. This is the distinguishing character of an Easy Beat song.

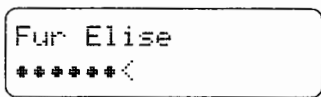

Press any key with a steady rhythm.

Key on

x x x x x x x x x x x x x x x x x x

MELODY PLAY

These songs are also quite easy to play, especially if they are familiar to you. To perform them, tap out the rhythm of the melody on any key on the keyboard. Singing along as you tap the rhythm can be helpful.

Play “Twinkle, Twinkle, Little Star” for example. Follow the melody’s rhythm as shown.

Key on x x x x x x x x x x x x x x



When performing fast songs with Concert Magic, it is sometimes easier to tap two different keys with two fingers alternating. This allows you to play twice as fast as you can using only one finger on one key.

SKILLFUL

These songs range in difficulty from moderately difficult to difficult. To perform them, tap out the rhythm of both the melody and the accompaniment notes on any key on the keyboard, like “Waltz of the Flowers” shown below. The Note Navigator will be very helpful with the Skillful songs.

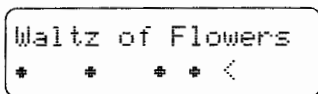

Key on x x x x x x x x x x x x x



It may take some practice to get them just right. A good way to learn these songs is to listen to them first, and then try to tap out the rhythms that you hear.

◆ NOTE

In the song list on page 62, the arrangement type is marked next to each song title as “EB” for Easy Beat, “MP” for Melody Play and “SK” for Skillful.

4.6 STEADY BEAT

Regardless of which arrangement type a Concert Magic song is, with Steady Beat you can play any Concert Magic song by simply tapping any key with a constant steady beat.

Press and hold the CONCERT MAGIC button. The LCD display will change to show the current Concert Magic mode in the second line.

Twinkle Twinkle
NORMAL

The current mode is NORMAL.

While still holding the CONCERT MAGIC button, **use the VALUE button to change the Concert Magic mode to STEADY BEAT.**

Twinkle Twinkle
STEADY BEAT

The mode is changed to STEADY BEAT.

Start by tapping any key with a constant steady beat. Your tapping will set the tempo for the song. Both the accompaniment and melody parts will be played automatically in time with the tempo you tap.

4.7 CONCERT MAGIC SONG DEMO

There are two ways to listen to the Concert Magic songs in the DEMO mode.

1. Press the piano key to which the desired song is assigned while holding down the DEMO button.

The CA piano will play back the selected song and, then play the rest of the songs in the same song category one after another.

2. Press the CONCERT MAGIC button and then press the DEMO button.

The CA piano will play back all of the Concert Magic songs in random order.

To stop the demo, press the DEMO button again.

To select the songs in different categories, select a song from the desired category.

4.8 ADJUSTING THE **PLAYBACK SPEED** FOR THE **CONCERT MAGIC SONGS**

The TEMPO button is also used to adjust the playback speed for the Concert Magic songs.

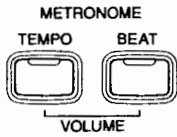

After selecting a Concert Magic song to play back, hold down the TEMPO button. The LED display will show the tempo value. While holding down the TEMPO button, use the VALUE buttons to change the tempo.

You can adjust the tempo, either before playing back a song or while the song is playing back.

5. VIRTUAL TECHNICIAN AND MENU FUNCTIONS

5.1 VIRTUAL TECHNICIAN BUTTON



A piano technician is essential to an acoustic piano. He not only tunes the piano but also performs regulation and voicing adjustments to make the piano sound and play better. Virtual Technician simulates the work of a piano technician electronically and allows you to customize the CA piano to your personal taste. These are the functions of Virtual Technician.

1. Voicing
2. Damper Effect
3. String Resonance
4. Touch
5. Temperament
6. Key of Temperament
7. Stretch Tunin
8. Piano Ambience (CA9 only)

COMMON OPERATION

To select a function that you want to adjust, press **VIRTUAL TECHNICIAN** button. The LCD will display “1 Voicing”, the first item in the menu.

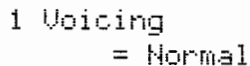
A rectangular LCD display with a thin border. The text "1 Voicing" is on the top line and "= Normal" is on the bottom line, both centered.

1 Voicing
= Normal

Press either of the **MENU** buttons to select a different function to edit.

Use the **VALUE** buttons to change value.

To exit the **VIRTUAL TECHNICIAN** menu, press any **SOUND SELECT** button.

◆ NOTE

After you have customized the CA piano using the **VIRTUAL TECHNICIAN** functions you can use the “User Memory” function to save your settings. This way all of your current **VIRTUAL TECHNICIAN** settings will remain after the power is turned off.

For more information about the “User Memory” function please see page 46 in this section of the manual.

1. VOICING

Voicing is a technique used by piano technicians to mold the character of a piano's sound. The Voicing function lets you change the CA piano's tone quality by choosing one of four types of voicings.

Bright 1, 2 Produces a brighter tone throughout the entire dynamic range. Bright 2 is brighter than Bright 1.

Dynamic The tone will change dramatically from mellow to bright with your playing.

Mellow 1, 2 Produces a mellower tone throughout the entire dynamic range. Mellow 2 is mellower than Mellow 1.

Normal Produces the normal timbre of an acoustic piano throughout the entire dynamic range. This is the preset value.

After selecting the "Voicing" function by pressing the MENU buttons, use the VALUE buttons to select a desired voicing type.

```
1 Voicing
  = Bright 1
```

The LCD display shows the type of voicing currently selected.

The current voicing selection is global for all the preset tones. You can not have an individual setting for each tone.

◆ NOTE

While voicing is a technique used for optimizing the tone of an acoustic piano, this function can be used on all the sounds on the CA piano.

2. DAMPER EFFECT

When the sustain pedal is depressed on an acoustic piano, all the dampers are lifted up allowing the strings to vibrate freely. When you play a note or chord on the piano with the sustain pedal depressed not only will the strings for the notes you played vibrate but other strings will vibrate in sympathetic resonance. The Damper Effect function simulates this phenomenon. You can select the level of effect from off, 1 to 10. The default setting is 5.

After selecting the "Damper Effect" function by pressing the MENU buttons, use the VALUE buttons to select the desired setting.

```
2 DamperEffect
  = 5
```

The LCD display shows the setting.

3. STRING RESONANCE

Even when the sustain pedal is not depressed on an acoustic piano, the strings for any notes you are holding will be un-damped and will resonate freely in sympathy with the strings of other notes that you play if they are part of the same harmonic series. In addition, adjacent notes will also be resonated. The String Resonance function simulates this phenomenon. You can select the level of resonance from off, 1 to 10. The default setting is 5. String resonance is not active when the damper pedal is depressed.

After selecting the “String Resonance” function by pressing the MENU buttons, use the VALUE buttons to select the desired setting.

A rectangular LCD display showing the text "3 String Reso." on the top line and "= 5" on the bottom line.

The LCD display shows the setting.

4. TOUCH

Touch lets you select a different touch sensitivity for the keyboard from the standard touch of an acoustic piano. You can change the sensitivity to one of five different settings: LIGHT, LIGHT+, HEAVY, HEAVY+, OFF and User 1/2.

- Light** For those still developing finger strength. A louder volume is produced even when playing with a soft touch.
- Light+** For players with a delicate touch. Requires less striking force to achieve a forte note.
- Heavy** Perfect for those with strong fingers. Requires a heavier touch to produce a loud volume.
- Heavy+** Requires more striking force to achieve a loud volume.
- Off** A constant volume is produced regardless of how hard the keys are struck. This setting is suitable for sounds that have a fixed dynamic range such as Organ and Harpsichord.
- User 1/2** You can create your own custom touch curve to fit your playing style. Two user touch curves can be saved.

After selecting the “Touch” function by pressing the MENU buttons, use the VALUE buttons to select your desired touch type.

A rectangular LCD display showing the text "4 Touch" on the top line and "= Light" on the bottom line.

The LCD display shows the touch type currently selected. Normal is the default setting.

Touch selection is global for all the preset tones. You can not have an individual setting for each tone.

◆ NOTE

LIGHT and HEAVY do not represent the physical weight of the keys. These are settings that affect the sensitivity of the keys, which determines the volume level in response to the key movement.

USER TOUCH

After selecting the “Touch” function by pressing the MENU buttons, use the VALUE buttons to select User 1 or User 2.

```
3 Touch
=User1→Press REC
```

Press the REC button.

```
Start Playing
Soft → Loud
```

Now start playing the CA piano dynamically from soft to loud in order to let the CA piano analyze your playing style.

```
Press STOP
when finished
```

While you are playing, a musical note will blink in the right corner of the LCD display.

Press the STOP button when you finish playing.

```
analysis
completed
```

The CA piano will analyze your playing and create a custom touch curve for you based upon your playing style.

◆ NOTE

The user touch curve data is saved automatically even after the power is turned off. However, You must re select the user touch curve each time the power is turned on unless you save it as your default touch curve by using the User Memory function. Please see page 46 in this section for more information on User Memory.

5. TEMPERAMENT

The CA piano offers not only equal temperament (the modern standard) but also immediate access to temperaments popular during the Renaissance and Baroque periods. It should be interesting and educational to try some of the different temperaments, although the equal temperament is dominant today.

After Selecting the “Temperament” function by pressing the MENU buttons, use the VALUE buttons to select your desired temperament.

5 Temperament
= Equal(P.only)

The LCD display shows the type of temperament currently selected.

BRIEF EXPLANATION OF TEMPERAMENTS

EQUAL TEMPERAMENT (PIANO ONLY)

5 Temperament
= Equal(P.only)

This is the default temperament. If a piano sound is selected the tuning is stretched like an acoustic piano (EQUAL TEMPERAMENT). If any other type of sound is selected the tuning will be EQUAL (FLAT). An explanation of EQUAL TEMPERAMENT and EQUAL TEMPERAMENT (FLAT) is provided later in this section.

◆ NOTE

If a piano sound is used in a layer with any other sound then both sounds will use the EQUAL TEMPERAMENT (Stretched) tuning.

MERSENNE PURE TEMPERAMENT (MAJOR)

MERSENNE PURE TEMPERAMENT (MINOR)

5 Temperament
= Pure(Major)

This temperament, which eliminates dissonance's for thirds and fifths is still popular for choral music because of its perfect harmony.

5 Temperament
= Pure(minor)

You need to be aware what key you are playing in with this temperament. Any key modulation will result in dissonance's. When you play music in a particular key, you need to match the key of the temperament as well. When playing in a major key select Pure (Major) and when playing in a minor key select Pure (minor).

PYTHAGOREAN TEMPERAMENT

5 Temperament
= Pythagorean

This temperament, which uses mathematical ratios to eliminate dissonance for fifths, is very limited for use with chords, but it produces very characteristic melodic lines.

MEANTONE TEMPERAMENT

5 Temperament
= Meantone

This temperament, which uses a mean between a major and minor whole tone to eliminate dissonance for thirds, was devised to eliminate the lack of consonance's experienced with certain fifths for the Mersenne pure temperament. It produces chords that are more beautiful than those with the equal temperament.

**WERCKMEISTER III TEMPERAMENT
KIRNBERGER III TEMPERAMENT**

5 Temperament
= Werckmeister

5 Temperament
= Kirnberger

These two temperaments are placed between Meantone and Pythagorean. For music with few accidentals, this temperament produces the beautiful chords of the mean tone, but as accidentals increase, the temperament produces the characteristic melodies of the Pythagorean temperament. It is used primarily for classical music written in the Baroque era to revive the original characteristics.

EQUAL TEMPERAMENT (FLAT)

5 Temperament
= Equal(flat)

This is “unstretched” equal temperament that divides the scale into twelve equal semitones. This produces the same chordal intervals in all twelve keys, and has the advantage of limitless modulation of the key. However the tonality of each key becomes less characteristic and no chord is in pure consonance.

EQUAL TEMPERAMENT

5 Temperament
= Equal

This is the most popular piano temperament. The hearing ability of a human is uneven and is not as accurate with high frequency and low frequency as it is with the middle range. This temperament’s tuning is stretched to compensate for this so the sound will be heard naturally to the ears. This “Stretched” equal temperament is a practical variation of the “unstretched” equal temperament which was invented on a mathematical basis.

USER TEMPERAMENT

5 Temperament
= User

You can make your own temperament by raising or lowering the pitch for each half tone.

Select the User temperament by using the VALUE buttons. Then use the MENU buttons to show the pitch data for each half tone.

5 Temperament
C = 0

The display shows the current pitch for C key.

**Use the VALUE buttons to change the pitch by cent.
Continue the same procedure to set the pitch for all keys.**

◆ NOTE

The user temperament data is saved automatically even after the power is turned off. However, You must re select the user temperament each time you turn the power on unless you save it as your default temperament by using the User Memory function. Please see page 46 in this section for more information on User Memory.

◆ NOTE

After you have selected the desired temperament, please read the following section on selecting a key signature for the temperament before continuing.

6. KEY OF TEMPERAMENT

Limitless modulation of the key became available only after the invention of Equal temperament. When we use a temperament other than Equal temperament, we must carefully choose the key signature to play in. For example, if the song you are going to play is written in D major, choose “D” as the temperament key.

After selecting the “Key Signature” function by pressing the MENU buttons, use the VALUE buttons to set the desired key.

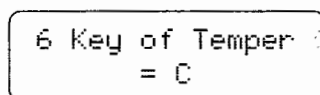

The LCD display shows the currently selected key signature.

Please note that changing the key of the temperament will only change the “balance” of the tuning, the pitch of the keyboard remains unchanged. Use the TUNING or TRANSPOSE functions to change the pitch of the whole keyboard.

◆ NOTE

This function is not displayed when Equal temperament is selected.

7. STRETCH TUNING

This function determines the level of stretch tuning. You can select either Normal or Wide.

After selecting the “Stretch Tuning” function by pressing the MENU buttons, use the VALUE buttons to select the desired setting.

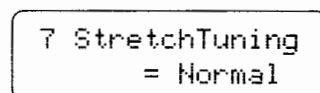

The LCD display shows the setting.

◆ NOTE

This function appears in the LCD screen only when you selected Equal or Equal (Piano Only) temperament.

8. PIANO AMBIENCE (CA9 ONLY)

This function adjusts the volume balance of the top mounted speakers. You can select the volume level from off, 1 to 10. The default setting is 5.

After selecting the “Piano Ambience” function by pressing the MENU buttons, use the VALUE buttons to select the desired setting.

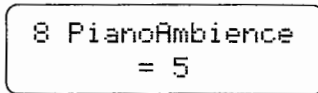

The LCD display shows the setting.

5.2 MENU BUTTONS

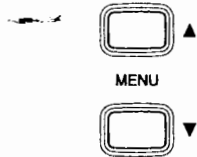

These buttons are used to access the various functions that control the CA piano's tuning, system and MIDI functions. They are:

1. Brilliance
2. Lower Octave Shift
3. Lower Pedal On/Off
4. Layer Octave Shift
5. Layer Dynamics
6. Damper Hold
7. Tuning
8. MIDI Channel
9. Transmit Program Change Number
10. Local Control On/Off
11. Transmit Program Change Number On/Off
12. Multi-Timbral Mode On/Off
13. Channel Mute (MIDI Ch. On/Off)
14. User Memory
15. Factory Reset

COMMON OPERATION

To select a function that you want to adjust, press either of the MENU buttons. The LCD will display “1 Brilliance”, the first item in the menu.

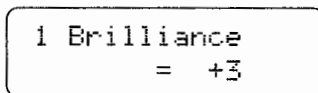

Press the MENU buttons again to select a different function to edit.

Use the VALUE buttons to change value.

To exit the function menu, press any SOUND SELECT button.

◆ NOTE

Once the power is turned off, all settings will be reset to the factory preset values unless you use the “User Memory” function to save your current settings.

For more information about the “User Memory” function please see page 46 in this section of the manual.

1. BRILLIANCE

Brilliance lets you adjust brightness of the preset sounds.

After selecting the “Brilliance” function by pressing the MENU buttons, use the VALUE buttons to change the value to the desired amount.

1 Brilliance
= +3

The LCD display shows the brilliance setting with a number. “0” indicates the standard setting.

Brilliance can be set between -10 to +10. Plus settings produce a brighter tone, minus settings produce a mellower tone.

Brilliance settings are global for all the preset sounds. You can not have an individual setting for each sound.

2. LOWER OCTAVE SHIFT

This allows the octave of the lower part to be shifted up one, two, or three octaves higher when you use the split function.

After selecting the “Lower Octave Shift” function by pressing the MENU buttons, use the VALUE buttons to select your desired shift range.

2 LowerOctShift
= 1

The LCD display shows the lower part is shifted one octave up.

Lower Octave Shift can be set between 0 to 3.

3. LOWER PEDAL ON/OFF

This determines if the sustain pedal will be active for lower sound when in SPLIT mode. The default setting is Off which means the sustain pedal is not active the lower sound.

After selecting the “Lower Pedal” function by pressing the MENU buttons, use the VALUE buttons to turn it on and off.

3 Lower Pedal
= On

The LCD display shows whether Lower Pedal is on or off.

4. LAYER OCTAVE SHIFT

This allows the octave of the layered part to be shifted up or down when you use the dual function.

After selecting the “Layer Octave Shift” function by pressing the MENU buttons, use the VALUE buttons to select your desired shift range.

```
4 LayerOctShift
  = 1
```

The LCD display shows the layered part is shifted one octave up.

Layer Octave Shift can be set between -2 to 2.

5. LAYER DYNAMICS

In Dual mode sometimes simply adjusting the volume balance between the two layered sounds is not enough to create the desired sound character if both sounds are very dynamic. Two equally dynamic sounds can be difficult to control and play comfortably. The Layer Dynamics function allows you to limit the overall dynamic sensitivity of the layered sound to create a perfect blend between both sounds in a layer. In addition to reducing the volume of the layered sound, limiting the dynamic sensitivity of the layered sound also makes the layered sound easier to control in relation to the main sound as you play. With this function, you can comfortably play as dynamically as you like with the main sound while maintaining control of the layered sound.

After selecting the “Layer Dynamics” function by pressing the MENU buttons, use the VALUE buttons to select the desired Dynamics level.

```
5 Layer Dynamics
  = 10
```

The LCD display shows the dynamics of the layered sound is 10 (dynamics of the layered sound are unchanged).

You can select the level of dynamics from 1 to 10. A value of 1 produces the greatest reduction in dynamics and a value of 10 produces no change in the dynamics. The default value is 10.

6. DAMPER HOLD

This determines if the sound such as organ or strings should be held (on) or gradually decayed (off) when the damper pedal is depressed.

After selecting the “Damper Hold” function by pressing the MENU buttons, use the VALUE buttons to turn it on and off.

6 Damper Hold
= Off

The LCD display shows the damper hold is off.

The default setting is off.

7. TUNING

Tuning allows you to adjust the piano's pitch. You may need to adjust the tuning when you play with other instruments.

After selecting the "Tuning" function by pressing the MENU buttons, use the VALUE buttons to adjust the tuning.

7 Tuning
= 440.0

The LCD display shows the current pitch setting.

The LCD display shows the pitch for "A" in Hz (Hertz). The range of adjustment is from 427.0 to 453.0 Hz. The factory preset value is set to the modern standard A = 440.0 Hz.

8. MIDI CHANNEL

This determines on which MIDI channel the CA piano will exchange MIDI information with an external MIDI instrument or a personal computer.

After selecting the "MIDI Channel" function by pressing the MENU buttons, use the VALUE buttons to select your desired number.

8 MIDI Channel
= 1 (TRS/RCV)

The LCD display shows the currently selected channel number.

9. SENDING PROGRAM CHANGE NUMBERS

This function allows the CA piano to transmit program change numbers beyond the 80 (CA9) or 60 (CA7) pre-defined numbers transmitted by the sound select buttons. Using this function, you can send any number from 1 to 128.

After selecting the "Send PGM #" function by pressing the MENU buttons, use the VALUE buttons to select your desired number.

9 Send PGM #
= 124 (UP+DOWN)

The LCD display shows the program change number.

To send the program change number, press both VALUE buttons simultaneously.

10. LOCAL CONTROL ON/OFF

This determines whether the CA piano's sound will be played from the piano's keyboard ("ON") or only from an external MIDI instrument ("OFF").

Even with local control "off" the piano's keyboard will still transmit to an external MIDI instrument or personal computer.

After selecting the "Local Control" function by pressing the MENU buttons, use the VALUE buttons to turn on and off.

10 Local Control
= On

The LCD display shows whether Local Control is on or off.

11. TRANSMIT PROGRAM CHANGE ON/OFF

This determines whether or not the CA piano will transmit program change information when pressing the SOUND SELECT buttons. When this is turned on, pressing the SOUND SELECT buttons will send the program change numbers as listed in page 58.

After selecting the "Transmit PGM" function by pressing the MENU buttons, use the VALUE buttons to turn it on and off.

11 Transmit PGM
= On

The LCD display shows whether or not program change numbers will be transmitted.

12. MULTI-TIMBRAL MODE

Multi-timbral mode allows the CA piano to receive data on more than one MIDI channel simultaneously. In this mode, the CA piano can play different musical parts with different sounds for each part.

Multi-Timbral On (On1 and On2)

This is a flexible 16 part multi-timbral setup. You can turn individual MIDI channels on and off, and assign any program number to any channel in the way you like. The CA piano's normal program change numbers are assigned in On1 (Please see page 58 for a list of the program change numbers), and General MIDI program change numbers are assigned in On2.

Multi-Timbral Off

This turns off the multi-timbral capability. Only one MIDI channel will be active and only the preset sound currently selected will be heard when a MIDI signal is received.

After selecting the “Multi-Timbre” function by pressing the MENU buttons, use the VALUE buttons to turn it on and off.

12 Multi Timbre
= On1

The LCD display shows the selected Multi-timbral mode.

13. CHANNEL MUTE

This determines which MIDI channels are activated to receive MIDI information when the Multi-Timbral mode is set to on. You can activate or deactivate each of the 16 channels individually.

Select the “Channel Mute” function by pressing the MENU buttons. Keep pressing the MENU buttons to select each of the sixteen channels

13 Channel Mute
Channel 1= Play

The LCD display shows the selected MIDI channel number.

Use the VALUE buttons to switch between PLAY and MUTE.

13 Channel Mute
Channel 1= Mute

Select “Play” to turn the channel on or “Mute to turn it off.

◆ NOTE

When the Multi-timbral mode is set to off, the “Channel Mute” function will not be displayed in the function menu.

14. USER MEMORY

This function allows the CA piano to save the user-definable settings when the power is turned off. Once written to the memory, the saved settings will be recalled every time you turn the power on.

The following settings can be saved—Effect settings, Metronome settings (tempo, time signature and volume), starting sound, primary sound for each sound category, all 13 menu functions, and all of the Virtual Technician functions.

Select the “User Memory” function by pressing the MENU buttons.

14 User Memory
Save →Press REC

Press the REC button to memorize your desired settings.

14 User Memory
Save completed

The LCD display briefly shows the above message and the current settings are saved.

◆ **NOTE**

The “User Memory” function does not automatically save any changes made to the settings every time the power is turned off. You must use the User Memory function each time you want to save your current settings.

15. FACTORY RESET

This function resets the CA piano to the factory settings. All parameters you saved in “User Memory” will be reset to the factory preset values.

Select the “Factory Reset” function by pressing the MENU buttons.

15 Factory Reset
Reset→Press REC

Press the REC button to reset the CA piano.

◆ **NOTE**

This function will not be displayed in the function menu until you save your settings in User Memory.

SONG data in RECORDER, User Touch and User Temperament will not be reset by this function.

In this chapter you will learn how you can create music by connecting the CA piano to an external MIDI device.

The CA piano is compatible with MIDI devices from Kawai and other manufacturers. It can also be used with sequencing software on a personal computer.



6. USING MIDI

UNDERSTANDING MIDI

WHAT IS MIDI?

The letters MIDI stand for Musical Instrument Digital Interface, an international standard for connecting MIDI equipped synthesizers, drum machines, and other electronic instruments so that they can exchange data. Personal computers can also be equipped for MIDI communication. Electronic instruments equipped with MIDI can transmit and receive performance data such as, notes, what sound to play, pedal information, volume, etc. This data can be recorded with a device like a sequencer or a computer.

MIDI JACKS

Instruments equipped with MIDI usually have three jacks for exchanging data: **IN**, **OUT**, and **THRU**. (Some instruments have only IN and OUT.) These jacks are used to connect MIDI devices to one another using a special cable.

Each terminal has a different function.

IN : For receiving MIDI data from another MIDI instrument.

OUT : For sending MIDI data to another MIDI instrument.

THRU : For passing along MIDI data received to another MIDI instrument without processing.

Depending on how they are connected, instruments are grouped as those which receive data (producing sound when data is received from a connected instrument), those which send data (to instruments to which they are connected), and those which both send and receive data.

MIDI CHANNEL

MIDI uses what are known as “**channels**” as a means of routing MIDI data intended to play a specified instrument or specified part. By channelizing MIDI data, you can control multiple parts in multiple instruments with a single cable.

There are two aspects of channels, one for receiving and one for sending. The MIDI channel of the receiving instrument must be matched with the MIDI channel of the transmitting instrument. The idea is just like television or radio. If you have a desired station to watch or listen to, you need to tune in to the right channel. When a transmitting instrument uses channel 1, the receiving instrument must be set to use channel 1 also. The CA piano lets you set the same channel number for both Transmit and receive.

There are 16 MIDI channels available to choose from on the CA piano. In addition to channel-to-channel connection, it is possible to receive multiple channels. With MIDI instruments equipped with **multi-timbral capabilities**, you can receive multiple parts on multiple channels each played with a different sound simultaneously. For example, a MIDI instrument might receive the melody on channel 1, the chords on 2, the bass on 3, and assign a different instrument to each channel. Piano for channel 1, strings for 2, electric bass for 3. In this way, the CA piano can play up to 16 different parts each with a different sound.

Here's a diagram to summarize the MIDI connections we have discussed.

Instrument #1, which is transmitting the piano part on channel 1 (Ch 1), the string part on Ch 2 and the bass part on Ch 3, is connected to Instrument #2. Instrument #3 is connected to MIDI Thru on instrument #2. The receive channel is set to 1 for Instrument #2 and multi-timbral mode is turned off. On instrument #3 multi-timbral mode is on.

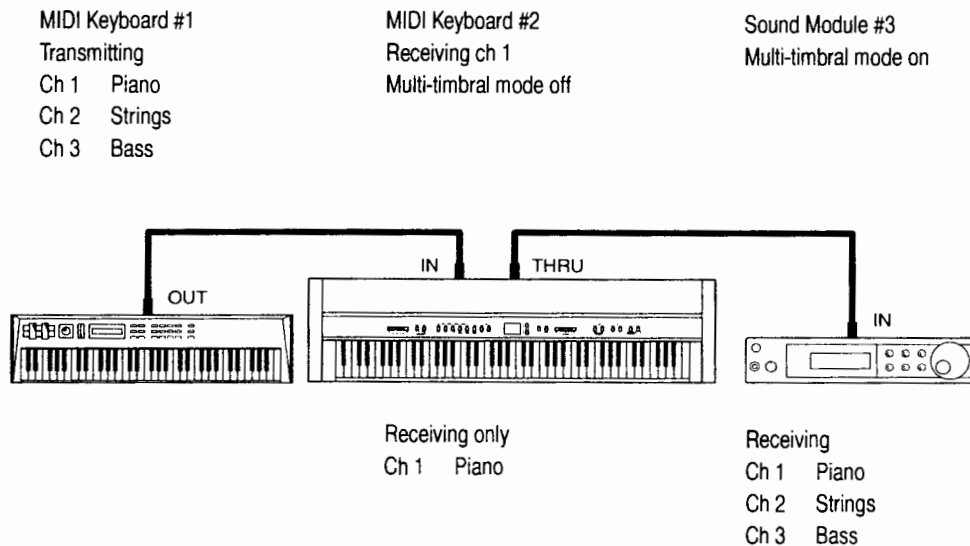

Instrument #2 recognizes only the piano part received from Instrument #1. Instrument #3 receives all the parts on the three channels being passed through Instrument #2 because Instrument #3's multi-timbral mode capability is activated.

We have provided this brief look at MIDI to help you understand the CA piano's MIDI capabilities.

While it is beyond the scope of this manual to explain the entire world of MIDI we do encourage you to visit your local music store or contact a music publisher for a listing of available books on MIDI applications to learn more.

Let's explore some MIDI applications using an external MIDI device connected to the CA piano.

6.1 USING THE CA PIANO AS CONTROLLER

First let's play sounds from an external MIDI device using the CA piano's keyboard.

MIDI CONNECTION

First, connect the CA piano's MIDI OUT jack to your external MIDI device's MIDI IN jack with a MIDI cable.

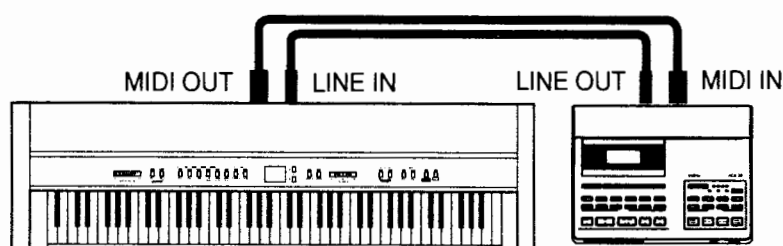

Next you must match the MIDI channel. The transmitting channel of the CA piano and receiving channel of your external MIDI device must be the same.

CHANGING TRANSMITTING CHANNEL

To change the transmit channel on the CA piano, press the MENU button several times until you see "9. MIDI Channel".

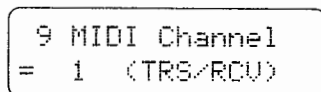

The LCD display will indicate the channel number that is currently selected.

Change the channel by using the VALUE buttons. You can select from 1 to 16.

Press any SOUND SELECT button to exit from the function menu.

AUDIO CONNECTION

If your external MIDI device is not equipped with an amplifier or speakers, you can connect it directly to the CA piano using the LINE IN jacks or to an external sound system.

Connect the LINE IN jacks of the CA piano and the LINE OUT (audio output) jacks of your external MIDI device with a pair of audio cables (see the illustration above). Now you will be able to hear the CA piano's sound and your external MIDI device's sound together through the CA's speakers. Use the volume control on your external MIDI device to balance it's volume with the CA piano.

Now You're ready to play.

Play the CA piano's keyboard. You should hear both instruments as you play. What is happening is that the CA piano is transmitting MIDI information, what note you played, how hard (loud) you played it, and so on to your external MIDI device. The external MIDI device reproduces sound based on this information using its own sound module.

PROGRAM CHANGE

Press a SOUND SELECT button on the CA. You will hear the sound on your external MIDI device also changes. Pressing a SOUND SELECT button lets the CA piano transmit a "**program change**" number. A program change is the type of MIDI command that tells the receiving instrument what sound or instrument to play your notes with.

Actual program change information is just a number, from 1 to 128, not an instrument name. You select the desired instrument with a specific number. Not all MIDI instruments assign the same sound to the same program change number. MIDI instruments that conform to the General MIDI (GM) standard however "DO" assign the same sound to the same program change number. For example program change #1 will always be an acoustic piano sound on a "GM" compatible synth, and program change #33 will always be an acoustic bass sound. Because of this, when connecting two "GM" instruments together, selecting the right sound is not a problem. The CA piano is not a General MIDI instrument and its internal sounds do not conform to the General MIDI standard. This means when you select a sound on the CA piano such as Classic E. Piano you will probably hear a different sound playing from your external MIDI device. What sound you hear will depend

on the sound assignments on your external MIDI device. Below is a chart of the Program Change number/sound assignment mapping for the first twelve CA piano sounds and the first twelve “GM” sounds. Please see page 58 for more detail. The CA piano can have different mappings depending on the setting for multi-timbral mode (explained later in this chapter).

Program #	CA9	CA7	General MIDI
1	Concert Grand	Concert Grand	Grand Piano
2	Studio Grand	Studio Grand	Bright Piano
3	Mellow Grand	Mellow Grand	Electric Grand
4	Jazz Grand	Jazz Grand	Honky Tonk Piano
5	Modern Piano	Modern Piano	Electric Piano 1
6	Honky Tonk	Honky Tonk	Electric Piano 2
7	Rock Piano	Concert Grand 2	Harpichord
8	New Age Piano	Studio Grand 2	Clavi
9	Concert Grand 2	Mellow Grand 2	Celesta
10	Studio Grand 2	Jazz Grand 2	Glockenspiel
11	Mellow Grand 2	New Age Piano 2	Music Box
12	Jazz Grand 2	New Age Piano 3	Vibraphone

In order for your external MIDI device to play the sound you want, you need to know what program change number to transmit to it. Please read your external MIDI device’s manual for a list of its program change number/sound assignments. Then read “Sending Program Change Numbers” on page 44 for the procedure to send a desired program change number from the CA piano.

That is how to layer the CA piano’s sound with a desired sound from an external MIDI device.

LOCAL CONTROL

You may want to play and only hear your external MIDI device’s sound, without the CA piano’s sound. You can turn off the CA piano’s sound using a function called “local control”.

Local control determines whether or not the CA piano will produce a sound when you play it’s own keyboard. When local control is on, the CA piano produces sound as you play the keys. When off, the piano will not produce a sound when you play the keys. The CA piano’s keyboard will however, continue to transmit MIDI information to an external MIDI device.

Press the MENU buttons until you see “10. Local Control”.

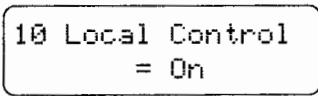

The LCD display will read “on”, which means the piano is currently set to local control on.

To turn it off, use the VALUE buttons.

Press any SOUND SELECT button to exit from the function menu.

Play the keyboard and you will hear only the sound from your external MIDI device.

To change the sound from the CA piano, select the desired number as explained in the Reference section and send it from the CA piano to your external MIDI device.

It may be possible to change preset sounds directly on your external MIDI device. In this case you may want to set the CA piano so that it does not transmit program changes. Read “11. Transmit Program Change On/Off” on page 45 to learn how to prevent the CA piano from transmitting program changes.

6.2 USING THE CA PIANO AS A MULTI-TIMBRAL SOUND MODULE

The CA piano can also be used as a 16-part multi-timbral sound module. Your CA piano is capable of playing back for example, a four part song with two piano parts, a string part, and a choir part all sent from an external MIDI sequencer or a personal computer. You can also play the CA piano along with a recorded song.

To set the CA piano to receive MIDI as a multi-timbral instrument it must be connected with an external MIDI device or personal computer with appropriate software.

Connect the CA piano’s MIDI IN jack and your external MIDI device’s MIDI OUT jack with a MIDI cable. Please note that the MIDI information is now being transmitted the opposite of our earlier setup. The CA piano is now receiving MIDI data from your external MIDI device.

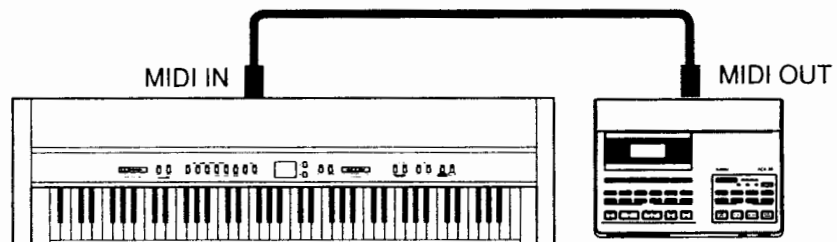

MIDI CHANNEL

The next step is to match your MIDI channels. When receiving MIDI data on the CA piano with multi-timbral mode ON, it is not necessary to specify a MIDI channel to use because the CA piano can receive data on multiple MIDI channels at once. You do have to be careful to match MIDI channels between each part. A MIDI channel can only have one sound assigned to it at a time. You must set the MIDI channel for each part on both the transmitting (external MIDI device) and the receiving (CA piano) MIDI devices. For example, channel 1 for piano, ch 2 for strings, ch 3 for choir, etc.

MULTI-TIMBRAL MODE

Multi-timbral On is a setup for 16-channel multi-timbral operation. You can mute the channels separately. Each channel recognizes the program change numbers as listed on page 58. There are two kinds of Multi-timbral On. On1 and On2 have different program change numbers assigned.

Multi-timbral Off turns off the multi-timbral capability. If you would like to have the CA piano receive MIDI data on a single channel and ignore all data on the other channels set multi-timbral to “Off”. Remember, if you want the CA piano to receive MIDI information from an external device, in this setup you must match the receiving channel with the transmitting channel. Program change numbers are recognized as listed on page 58.

To demonstrate the multi-timbral capability of the CA piano, let's choose Multi-timbral On.

Press the MENU buttons until you see “12. Multi Timbre”.

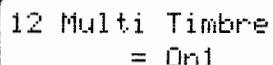

12 Multi Timbre
= On1

The LCD display will read “OFF”, which means Multi-timbral Off is currently selected.

Use the VALUE buttons to select Multi-timbral On. The display will read “On1” or “On2”.

After choosing the multi-timbral setting, press any SOUND SELECT button to exit from the function menu.

Let's see how this works using an external MIDI device. If you have a keyboard connected to the CA piano try playing some notes. You should hear the CA piano as you play. If you have a MIDI song player or personal

computer with MIDI software connected try sending some MIDI song data with one or more different musical parts to the CA. Again you should hear the CA piano playing all the parts. In multi-timbral mode, if you want to hear a particular sound for each part you transmit to the CA you must send the correct Program/sound number from the transmitting MIDI device to the CA piano. Please see page 58 for a list of the Program/sound number assignments for the CA piano.

If you own a "GM" sound module you'll probably want to use it as your multi-timbral module instead of the CA piano. If you have a hardware sequencer or personal computer but do not own another sound module, you can enjoy sixteen-part multi-timbral capability with only the CA piano.

MIDI may seem a little difficult to work with at first, but once mastered it offers many new and exciting ways to enjoy music.

While this manual avoids going into too much detail regarding the technical aspects of MIDI such as "system exclusive data", for those who are more familiar with MIDI or want to be, this manual provides technical MIDI information and a MIDI Implementation Chart, on page 68 and 69.

7. JACKS

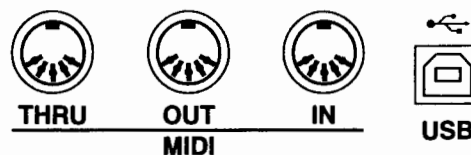
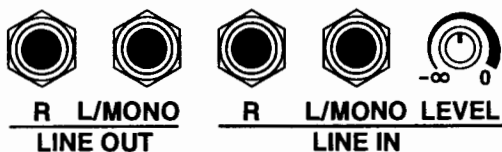

LINE OUT JACKS

These jacks provide stereo output of the piano's sound to amplifiers, tape recorders or similar equipment.

The audio signal coming through the LINE IN jacks is also routed to these jacks. The piano's sound is mixed with the LINE IN signals.

The CA piano's VOLUME slider can control the output level of its own sound while it does not control the LINE IN signal.

LINE IN JACKS

These jacks are used to connect a pair of stereo outputs from other audio equipment or electronic instruments to the piano's speakers.

The audio signal coming through these jacks bypasses the piano's volume control. To adjust the volume level, use the level control knob next to the LINE IN jacks.

MIDI JACKS

These jacks are used to connect external MIDI devices with the CA piano. There are three terminals: MIDI IN, MIDI OUT, and MIDI THRU.

USB JACK

This jack is used to connect with a personal computer and exchange MIDI data.

HEADPHONE JACKS

There are two jacks for headphones provided at the left end on the bottom of the piano.

You can hear the piano's sound as well as any audio signal that is coming through the LINE IN.

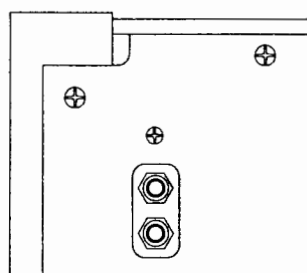

BOTTOM VIEW

NOTES ABOUT USB

The CA piano can be connected with a personal computer with a USB cable for exchanging MIDI data. You need a USB driver installed in your computer.

[For Windows XP/Me users]

A standard USB driver is already installed in your computer. You don't need to install a new driver.

[For Windows 2000/98SE users]

You need to install the designated driver in your computer. Visit the KAWAI web site at <http://www.kawai.co.jp/english/Download1.html> and download the program.

[For Macintosh users]

Currently we don't have a USB driver available for Macintosh computers. Please use an appropriate MIDI interface and MIDI cables when connecting the CA piano to a Macintosh computer.

NOTE:

When both MIDI jacks and USB jack are connected, USB has priority.

When connecting USB cable to the CA piano, first connect the USB cable and then turn the power of the CA piano on.

It may take some time to start communication when the CA piano is connected to the computer via USB.

When USB communication is unstable with connection via hub, connect the USB cable directly to the USB port of the computer.

Turning the power of CA piano on/off or disconnecting the USB cable while the following actions may cause unstable communication.

- while installing USB driver
- while booting up the computer
- while MIDI application is working
- while communicating with the computer
- while the computer is in energy saver mode

* If you have any problem with USB communication, consult the instruction manual of your computer and check your computer set up.

* The USB-MIDI conversion board TID10000934 used in the CA piano is approved to show the USB logo. The USB logo can be used only for the product which is approved by USB-IF (USB Implements Forum Inc.) test.

* Windows is registered trademark of Microsoft Corporation.

* Macintosh is registered trademark of Apple Computer, Inc.



8. APPENDICES

PROGRAM CHANGE NUMBER MAPPING

Sound	Multi-Timbral mode				
	Off, On 1		On 2		
	Prog # (CA9)	Prog # (CA7)	Bank MSB	Bank LSB	Prog #
Concert Grand	1	1	121	0	1
Studio Grand	2	2	121	1	1
Mellow Grand	3	3	121	2	1
Jazz Grand	4	4	95	8	1
Modern Piano	5	5	121	0	2
Honky Tonk	6	6	121	0	4
Rock Piano *	7	-	121	1	2
New Age Piano *	8	-	95	5	2
Concert Grand 2	9	7	95	16	1
Studio Grand 2	10	8	95	17	1
Mellow Grand 2	11	9	95	18	1
Jazz Grand 2	12	10	95	19	1
New Age Piano 2	13	11	95	9	1
New Age Piano 3	14	12	95	10	1
New Age Piano 4 *	15	-	95	11	1
New Age Piano 5 *	16	-	95	15	1
Classic E.Piano	17	13	121	0	5
Modern E.P.	18	14	121	0	6
60's E.P.	19	15	121	3	5
Modern E.P. 2	20	16	121	1	6
New Age E.P.	21	17	95	2	6
Crystal E.P.	22	18	95	1	6
Modern E.P. 3 *	23	-	121	2	6
New Age E.P. 2 *	24	-	95	3	6
Jazz Organ	25	19	121	0	18
Drawbar Organ	26	20	121	0	17
Drawbar Organ 2	27	21	121	1	17
Be 3	28	22	95	2	17
Jazzier	29	23	95	1	18
Odd Man	30	24	95	6	17
Hi Lo *	31	-	95	3	17
4' Drawbar *	32	-	95	4	19
Church Organ	33	25	121	0	20
Diapason	34	26	95	7	20
Full Ensemble	35	27	95	1	21
Diapason Oct.	36	28	95	6	20
Chiffy Tibia	37	29	95	17	20
Stopped Pipe	38	30	95	21	20
Principal Choir *	39	-	95	23	20
Baroque *	40	-	95	19	20

Multi-Timbral mode					
Sound	Off, On 1		On 2		
	Prog # (CA9)	Prog # (CA7)	Bank MSB	Bank LSB	Prog #
Harpsichord	41	31	121	0	7
Harpsichord 2	42	32	121	3	7
Vibraphone	43	33	121	0	12
Clavi	44	34	121	0	8
Marimba	45	35	121	0	13
Celesta	46	36	121	0	9
Harpsichord Oct *	47	-	121	1	7
Bell Sprit *	48	-	95	5	15
Slow Strings	49	37	95	1	45
String Pad	50	38	95	8	49
Warm String	51	39	95	1	49
String Ensemble	52	40	121	0	49
Full Orchestra	53	41	95	12	49
Small Strings *	54	-	95	13	49
Harp	55	42	121	0	47
Pizzicato Str. *	56	-	121	0	46
Choir	57	43	121	0	53
Pop Ooh	58	44	95	39	54
Pop Aah	59	45	95	40	54
Synth Vocal	60	46	121	0	55
Jazz Ensemble	61	47	95	2	54
Pop Ensemble	62	48	95	7	54
Slow Choir *	63	-	95	2	53
Breathy Choir *	64	-	95	1	53
New Age Pad	65	49	121	0	89
Atmosphere	66	50	121	0	100
Itopia	67	51	121	1	92
Brightness	68	52	95	1	101
New Age Pad 2	69	53	95	2	89
Brass Pad	70	54	95	2	62
Halo Pad *	71	-	121	0	95
Bright Warm Pad *	72	-	95	1	90
Wood Bass	73	55	121	0	33
Electric Bass	74	56	121	0	34
Fretless Bass	75	57	121	0	36
W. Bass & Ride	76	58	95	1	33
E. Bass & Ride *	77	-	95	2	34
Ballad Guitar	78	59	95	6	26
Pick Nylon Gt.	79	60	95	3	25
Finger Nylon Gt. *	80	-	95	4	25
Standard Drum Kit 1	81	61	120	0	1
Standard Drum Kit 2	82	62	120	0	33
Room Drum Kit	83	63	120	0	9
Analog Drum Kit	84	64	120	0	26

DRUM SOUND MAPPING

	Standard Kit 1	Standard Kit 2	Room Kit	Analog Kit
	C# Snare Roll	Snare Roll	Snare Roll	Snare Roll
	D Finger Snap	Finger Snap	Finger Snap	Finger Snap
	D# High Q	High Q	High Q	High Q
	E Slap	Slap	Slap	Slap
	F Scratch Push	Scratch Push	Scratch Push	Scratch Push2
	F# Scratch Pull	Scratch Pull	Scratch Pull	Scratch Pull2
	G Sticks	Sticks	Sticks	Sticks
	G# Square Click	Square Click	Square Click	Square Click
	A Metronome Click	Metronome Click	Metronome Click	Metronome Click
	A# Metronome Bell	Metronome Bell	Metronome Bell	Metronome Bell
	B Std1 BD2	Std2 BD2	Room BD2	Analog BD2
C2	C Std1 BD1	Std2 BD1	Room BD1	Analog BD1
	C# Rim	Rim	Rim	Analog Rim
	D Std1 SD1	Std2 SD1	Room SD1	Analog SD1
	D# Hand Clap	Hand Clap	Hand Clap	Hand Clap
	E Std1 SD2	Std2 SD2	Room SD2	Analog SD2
	F Std1 Low Tom2	Std2 Low Tom2	Room Low Tom2	Analog Low Tom2
	F# Std1 HHC	Std2 HHC	Room HHC	Analog HHC
	G Std1 Low Tom1	Std2 Low Tom1	Room Low Tom1	Analog Low Tom1
	G# Std1 HHP	Std2 HHP	Room HHP	Analog HHP
	A Std1 Mid Tom2	Std2 Mid Tom2	Room Mid Tom2	Analog Mid Tom2
	A# Std1 HHO	Std2 HHO	Room HHO	Analog HHO
	B Std1 Mid Tom1	Std2 Mid Tom1	Room Mid Tom1	Analog Mid Tom1
C3	C Std1 Hi Tom2	Std2 Hi Tom2	Room Hi Tom2	Analog Hi Tom2
	C# Std1 Crash1	Std2 Crash1	Room Crash1	Analog Crash1
	D Std1 Hi Tom1	Std2 Hi Tom1	Room Hi Tom1	Analog Hi Tom1
	D# Std1 Ride1	Std2 Ride1	Room Ride1	Analog Ride1
	E China	China	China	China
	F Cup	Cup	Cup	Cup
	F# Tambourine	Tambourine	Tambourine	Tambourine
	G Splash	Splash	Splash	Splash
	G# Cowbell	Cowbell	Cowbell	Analog Cowbell
	A Crash2	Crash2	Crash2	Crash2
	A# Vibra Slap	Vibra Slap	Vibra Slap	Vibra Slap
	B Ride2	Ride2	Ride2	Ride2
C4	C Hi Bongo	Hi Bongo	Hi Bongo	Hi Bongo
	C# Low Bongo	Low Bongo	Low Bongo	Low Bongo
	D Mute Hi Conga	Mute Hi Conga	Mute Hi Conga	Analog Hi Conga
	D# Hi Conga	Hi Conga	Hi Conga	Analog Mid Conga
	E Low Conga	Low Conga	Low Conga	Analog Low Conga
	F Hi Timbale	Hi Timbale	Hi Timbale	Hi Timbale
	F# Low Timbale	Low Timbale	Low Timbale	Low Timbale
	G Hi Agogo	Hi Agogo	Hi Agogo	Hi Agogo
	G# Low Agogo	Low Agogo	Low Agogo	Low Agogo
	A Cabasa	Cabasa	Cabasa	Cabasa
	A# Maracas	Maracas	Maracas	Analog Maracas
	B Short Whistle	Short Whistle	Short Whistle	Short Whistle
C5	C Long Whistle	Long Whistle	Long Whistle	Long Whistle
	C# Short Guiro	Short Guiro	Short Guiro	Short Guiro
	D Long Guiro	Long Guiro	Long Guiro	Long Guiro
	D# Claves	Claves	Claves	Analog Claves
	E Hi Wood Blk	Hi Wood Blk	Hi Wood Blk	Hi Wood Blk
	F Low Wood Blk	Low Wood Blk	Low Wood Blk	Low Wood Blk
	F# Mute Cuica	Mute Cuica	Mute Cuica	Mute Cuica
	G Open Cuica	Open Cuica	Open Cuica	Open Cuica
	G# Mute Triangle	Mute Triangle	Mute Triangle	Mute Triangle
	A Open Triangle	Open Triangle	Open Triangle	Open Triangle
	A# Shaker	Shaker	Shaker	Shaker
	B Jingle Bell	Jingle Bell	Jingle Bell	Jingle Bell
C6	C Bell Tree	Bar Chimes	Bar Chimes	Bar Chimes
	C# Castanets	Castanets	Castanets	Castanets
	D Mute Surdo	Mute Surdo	Mute Surdo	Mute Surdo
	D# Open Surdo	Open Surdo	Open Surdo	Open Surdo

RHYTHM STYLE LIST

1	8 Beat 1	26	Rim Beat	51	Hip Hop 3	76	Jazz Waltz 1
2	8 Beat 2	27	Slow Jam	52	Hip Hop 4	77	Jazz Waltz 2
3	8 Beat 3	28	Pop 1	53	Techno 1	78	5/4 Swing
4	16 Beat 1	29	Pop 2	54	Techno 2	79	Tom Swing
5	16 Beat 2	30	Electro Pop 1	55	Techno 3	80	Fast 4 Beat
6	16 Beat 3	31	Electro Pop 2	56	Heavy Techno	81	H.H. Bossa Nova
7	16 Beat 4	32	Ride Beat 1	57	8 Shuffle 1	82	Ride Bossa Nova
8	16 Beat 5	33	Ride Beat 2	58	8 Shuffle 2	83	Beguine
9	16 Beat 6	34	Ride Beat 3	59	8 Shuffle 3	84	Mambo
10	Rock Beat 1	35	Ride Beat 4	60	Boogie	85	Cha Cha
11	Rock Beat 2	36	Slip Beat	61	16 Shuffle 1	86	Samba
12	Rock Beat 3	37	Jazz Rock	62	16 Shuffle 2	87	Light Samba
13	Hard Rock	38	Funky Beat 1	63	16 Shuffle 3	88	Surdo Samba
14	Heavy Beat	39	Funky Beat 2	64	T Shuffle	89	Latin Groove
15	Surf Rock	40	Funky Beat 3	65	Triplet 1	90	Afro Cuban
16	2nd Line	41	Funk 1	66	Triplet 2	91	Songo
17	50 Ways	42	Funk 2	67	Triplet 3	92	Bembe
18	Ballad 1	43	Funk 3	68	Triplet 4	93	African Bembe
19	Ballad 2	44	Funk Shuffle 1	69	Triplet Ballad 1	94	Merenge
20	Ballad 3	45	Funk Shuffle 2	70	Triplet Ballad 2	95	Reggae
21	Ballad 4	46	Buzz Beat	71	Triplet Ballad 3	96	Tango
22	Ballad 5	47	Disco 1	72	Motown 1	97	Habanera
23	Light Ride 1	48	Disco 2	73	Motown 2	98	Waltz
24	Light Ride 2	49	Hip Hop 1	74	Ride Swing	99	Ragtime
25	Smooth Beat	50	Hip Hop 2	75	H.H. Swing	100	Country & Western

CONCERT MAGIC SONG LIST

BANK A

Title	Note#	Type
-------	-------	------

CHILDREN'S SONGS

Bingo	G#1	EB
Frère Jacques	F#1	MP
Good Morning To You	F1	MP
Hickory Dickory Dock	D#1	EB
I'm A Little Teapot	A#0	MP
Itsy, Bitsy Spider	A1	MP
London Bridges	C#1	MP
Mary Had A Little Lamb	C1	MP
Pop Goes The Weasel	E1	MP
Row, Row, Row Your Boat	D1	MP
The Farmer In The Dell	G1	MP
This Old Man	B0	MP
Twinkle, Twinkle, Little Star	A0	MP

CHRISTMAS SONGS

Deck The Halls	C2	MP
Hark The Herald Angels Sing	A#1	MP
Jingle Bells	B1	MP
Joy To The World	D2	MP
O Come All Ye Faithful	C#2	MP
Silent Night	E2	MP
The First Noel	D#2	MP
We Wish You A Merry Christmas	F2	MP
What Child Is This? (Greensleeves)	F#2	MP

PATORIOTIC SONGS

America The Beautiful	A2	MP
Battle Hymn Of The Republic	G#2	MP
Hail To The Chief	B2	MP
My Country 'Tis Of Thee	G2	MP
Yankee Doodle	A#2	MP

AMERICAN CLASSICS

Auld Lang Syne	C#4	MP
Beautiful Dreamer	A#4	EB
Bicycle Built For Two	F4	EB
Bill Bailey Won't You Please Come Home	G3	EB
Camptown Races	F#4	MP
Clementine	A3	MP
Danny Boy	C3	EB
Down In The Valley	C#3	EB
Fascination	A#3	SK
For He's A Jolly Good Fellow	F#3	EB
Give My Regards To Broadway	G#3	SK
Home On The Range	B3	MP
Home Sweet Home	D#3	EB
In The Good Old Summertime	F3	EB
Let Me Call You Sweetheart	D3	EB
Michael Row The Boat Ashore	D4	MP

My Bonnie Lies Over The Ocean	E3	EB
Oh Susanna	D#4	SK
On Top Of Old Smokey	E4	EB
Take Me Out To The Ballgame	C4	EB
The Band Played On	G4	EB
When Johnny Comes Marching Home	G#4	MP
When The Saints Go Marching In	A4	EB

FAVORITE HYMNS

A Mighty Fortress	D6	MP
Amazing Grace	C5	MP
Doxology	C#5	MP
Fairest Lord Jesus	B4	MP
For The Beauty Of The Earth	D5	MP
Great Is Thy Faithfulness	C#6	MP
Holy, Holy, Holy	F5	MP
How Great Thou Art	C6	MP
Jesus Loves The Little Children	B5	MP
Just As I Am	A#5	MP
O Worship The King	D#5	MP
Rock Of Ages	G5	MP
Sweet Hour Of Prayer	A5	MP
The Old Rugged Cross	E5	MP
Trust And Obey	G#5	MP
What A Friend We Have In Jesus	F#5	MP

CLASSICAL SELECTIONS

An Die Freude (Ode To Joy)	F6	MP
Andante (Haydn)	D#6	MP
Blue Danube Waltz	B6	SK
Clair De Lune	F#6	SK
Fledermaus	E7	EB
Für Elise	E6	EB
Gavotte (Gossec)	C#7	SK
Menuet In G (Bach)	A6	SK
Peter And The Wolf	G#6	SK
Romeo And Juliet	A#6	SK
Skater's Waltz	G6	SK
Sleeping Beauty Waltz	C7	EB
Toreador Song ("Carmen")	D#7	SK
Waltz Of The Flowers	D7	SK

SPECIAL OCCASIONS

Bridal Chorus	F7	MP
Wedding March	F#7	SK

INTERNATIONAL SONGS

Chiapenacas	C8	SK
Hatikvah	G#7	MP
Hava Nagilah	A#7	EB
Ich Bin Ein Musikant	B7	SK
My Wild Irish Rose	A7	EB
When Irish Eyes Are Smiling	G7	EB

BANK B

Title	Note#	Type			
			Shine On Harvest Moon	F3	SK
			Ta Ra Ra Boom De Ay	C3	EB
			The Entertainer	C#4	SK
			Thunder And Blazes	F#4	SK
			Turkey In The Straw	C#3	SK
			Wabash Cannonball	G#4	SK
			Yellow Rose Of Texas	G#3	SK
CHILDREN'S SONGS					
Brahm's Lullaby	D#1	SK			
Did You Ever See A Lassie?	C#1	MP			
Here We Go Round The Mulberry Bush	F1	MP			
Little Brown Jug	F#1	MP			
Old Macdonald Had A Farm	C1	MP			
Polly Wolly Doodle	A1	MP			
Rock A Bye Baby	E1	EB			
She'll Be Comin' Around The Mountain	G1	EB			
Ten Little Indians	D1	MP			
The Muffin Man	A#0	MP			
Three Blind Mice	B0	MP			
Where, O Where Has My Little Dog Gone?	A0	EB			
Whistler And His Dog	G#1	SK			
CHRISTMAS SONGS					
Angels We Have Heard On High	A#1	MP			
Ave Maria	F#2	SK			
Away In A Manger	C2	MP			
It Came Upon A Midnight Clear	B1	MP			
O Holy Night	C#2	EB			
O Little Town Of Bethlehem	F2	MP			
O Tannenbaum	D2	MP			
The Twelve Days Of Christmas	D#2	MP			
We Three Kings Of Orient Are	E2	MP			
PATORIOTIC SONGS					
Anchors Aweigh	A#2	SK			
Stars And Stripes Forever	A2	SK			
Under The Double Eagle	B2	SK			
Washington Post March	G2	SK			
You're A Grand Old Flag	G#2	EB			
AMERICAN CLASSICS					
After The Ball Is Over	E4	EB			
After You've Gone	F4	EB			
American Patrol March	F#3	MP			
Annie Laurie	G4	MP			
Arkansas Traveler	A#3	MP			
Blue Bells Of Scotland	D3	MP			
By The Light Of The Silvery Moon	E3	SK			
Dixie	G3	SK			
Down By The Riverside	D#3	SK			
Grandfather's Clock	A#4	EB			
I Love Coffee, I Love Tea	A3	MP			
I've Been Working On The Railroad	A4	EB			
Maple Leaf Rag	D#4	SK			
Old Folks At Home	D4	SK			
Old Kentucky Home	B3	SK			
Red River Valley	C4	EB			
FAVORITE HYMNS					
			All Hail The Power Of Jesus Name	C#6	MP
			Blest Be The Tie That Binds	D5	MP
			Christ The Lord Is Risen Today	B4	MP
			Come Thou Almighty King	D#5	MP
			Crown Him With Many Crowns	C#5	MP
			Gloria Patri	F#5	MP
			I Need Thee Every Hour	A5	MP
			It Is Well With My Soul (When Peace Like)	C5	MP
			My Jesus, I Love Thee	E5	MP
			Onward Christian Soldiers	C6	MP
			Savior Like A Shepherd Lead Us	A#5	MP
			Stand Up, Stand Up For Jesus	B5	MP
			Standing On The Promises	G#5	MP
			The Church's One Foundation	F5	MP
			The Solid Rock	G5	MP
			To God Be The Glory	D6	MP
CLASSICAL SELECTIONS					
			Allegro Moderato (Schubert)	E7	SK
			Can Can	F6	SK
			Emperor Waltz	F#6	SK
			Grand March ("Aida")	G#6	SK
			Gymnopedie	A6	SK
			Gypsy Chorus	A#6	SK
			Largo (Dvorák)	B6	SK
			March Militaire	G6	SK
			Norwegian Dance	D#6	SK
			Pizzicato Polka	C#7	SK
			Prelude In A (Chopin)	C7	MP
			Rondeau (Mouret)	D7	SK
			Voice Of Spring	D#7	EB
			William Tell Overture	E6	SK
SPECIAL OCCASIONS					
			Mazel Tov	F#7	EB
			Pomp And Circumstance	F7	SK
INTERNATIONAL SONGS					
			Funiculi Funicula	G7	SK
			Habanera	B7	SK
			La Bamba	C8	SK
			La Marseillaise	G#7	MP
			La Paloma	A7	SK
			Santa Lucia	A#7	SK

PIANO MUSIC SONG LIST

Screen Name	Song Title
Bach Air	Air D dur, BWV. 1068
Bach Prelude	Das Wohltemperierte Klavier, I Teil, 24 Praludium und Fuga, BWV.846 "PRALUDIUM C dur"
Bach Suite #1	French Suite No.1 "ALLEMANDE"
Bach Suite #2	French Suite No.3 "ALLEMANDE"
Bach Suite #3	French Suite No.5 "ALLEMANDE"
Bach Suite #4	French Suite No.5 "GAVOTTE"
Bach Suite #5	French Suite No.6 "ALLEMANDE"
Bach Suite #6	English Suite No.3 "GAVOTTE"
BeethovenSonata1	Sonata No.28 in A Major, op.101 1st MOV.
BeethovenSonata2	Sonata No.14 in C sharp Minor, op.27 No.2 "MOON LIGHT" 1st MOV.
BeethovenSonata3	Sonata No.14 in C sharp Minor, op.27 No.2 "MOON LIGHT" 2nd MOV.
BeethovenSonata4	Sonata No.8 in C Minor, op.13 "PATHETIQUE" 2nd MOV.
BrahmsIntermezzo	6 Stucke, op.118 No.2 "Intermezzo in A Major"
Brahms Valse	Walzer, op.39 "Valse As dur"
Debussy Clair	Suite Bergamasque "CLAIR DE LUNE"
Debussy Prelude	Suite Bergamasque "PRELUDE"
Debussy Reverie	Reverie
Faure Romance	3 Romances Sana Paroles No.3 in A flat Major, op.17
Field Nocturne 1	Nocturne No.10 in E Minor
Field Nocturne 2	Nocturne No.5 in B flat Major
Mendelssohn 1	Lieder Ohne Worte Heft 1 in E Dur, op.19b "SWEET REMEMBRANCE"
Mendelssohn 2	Lieder Ohne Worte Heft 8 in g moll, op.102 No.4 "THE SIGHING WIND"
Mozart Sonata 1	Sonata in A Major, K.331 1st MOV.
Mozart Sonata 2	Sonata in C Major, K.545 3rd MOV.
Mozart Sonata 3	Sonata in G Major, K.283 1st MOV.
Mozart Sonata 4	Sonata in G Major, K.283 2nd MOV.
Mozart Sonata 5	Sonata in G Major, K.283 3rd MOV.
Mozart Sonata 6	Sonata in F Major, K.547a 2nd MOV.
Schubert A.Maria	Ave Maria, D.839
Schumann Chopin	Chopin
SchumannCoquette	Coquette
SchumannReplique	Replique—Sphinxes
SchumannFantasie	Fantasiestucke op.12 "DES ABENDS"
Schumann Kinder1	Kinderszenen op.15 "BITTENDES KIND"
Schumann Kinder2	Kinderszenen op.15 "TRAUMEREI"
Schumann Kinder3	Kinderszenen op.15 "FURCHTENMACHEN"
Schumann Kinder4	Kinderszenen op.15 "VON FREMDEN LANDERN UND MENSCHEN"
Schumann Kinder5	Kinderszenen op.15 "GLUCKES GENUG"
Schumann Kinder6	Kinderszenen op.15 "FAST ZU ERNST"
Schumann Kinder7	Kinderszenen op.15 "KIND IM EINSCHLUMMERN"
Tchaikovsky 1	Barcarolle, op.37a-6
Tchaikovsky 2	Casse-Noisette, op.71A No.2-iv "DANCE ARABE"
Tchaikovsky 3	Morceaux de Fantasie in E flat Minor, op.3 No.1 "ELEGIE"

PIANO MUSIC SONG LIST

Screen Name	Song Title
Bach Air	Air D dur, BWV. 1068
Bach Prelude	Das Wohltemperierte Klavier, I Teil, 24 Praludium und Fuga, BWV.846 "PRALUDIUM C dur"
Bach Suite #1	French Suite No.1 "ALLEMANDE"
Bach Suite #2	French Suite No.3 "ALLEMANDE"
Bach Suite #3	French Suite No.5 "ALLEMANDE"
Bach Suite #4	French Suite No.5 "GAVOTTE"
Bach Suite #5	French Suite No.6 "ALLEMANDE"
Bach Suite #6	English Suite No.3 "GAVOTTE"
BeethovenSonata1	Sonata No.28 in A Major, op.101 1st MOV.
BeethovenSonata2	Sonata No.14 in C sharp Minor, op.27 No.2 "MOON LIGHT" 1st MOV.
BeethovenSonata3	Sonata No.14 in C sharp Minor, op.27 No.2 "MOON LIGHT" 2nd MOV.
BeethovenSonata4	Sonata No.8 in C Minor, op.13 "PATHETIQUE" 2nd MOV.
BrahmsIntermezzo	6 Stucke, op.118 No.2 "Intermezzo in A Major"
Brahms Valse	Walzer, op.39 "Valse As dur"
Debussy Clair	Suite Bergamasque "CLAIR DE LUNE"
Debussy Prelude	Suite Bergamasque "PRELUDE"
Debussy Reverie	Reverie
Faure Romance	3 Romances Sana Paroles No.3 in A flat Major, op.17
Field Nocturne 1	Nocturne No.10 in E Minor
Field Nocturne 2	Nocturne No.5 in B flat Major
Mendelssohn 1	Lieder Ohne Worte Heft 1 in E Dur, op.19b "SWEET REMEMBRANCE"
Mendelssohn 2	Lieder Ohne Worte Heft 8 in g moll, op.102 No.4 "THE SIGHING WIND"
Mozart Sonata 1	Sonata in A Major, K.331 1st MOV.
Mozart Sonata 2	Sonata in C Major, K.545 3rd MOV.
Mozart Sonata 3	Sonata in G Major, K.283 1st MOV.
Mozart Sonata 4	Sonata in G Major, K.283 2nd MOV.
Mozart Sonata 5	Sonata in G Major, K.283 3rd MOV.
Mozart Sonata 6	Sonata in F Major, K.547a 2nd MOV.
Schubert A.Maria	Ave Maria, D.839
Schumann Chopin	Chopin
SchumannCoquette	Coquette
SchumannReplique	Replique--Sphinxes
SchumannFantasie	Fantasiestucke op.12 "DES ABENDS"
Schumann Kinder1	Kinderszennen op.15 "BITTENDES KIND"
Schumann Kinder2	Kinderszennen op.15 "TRAUMEREI"
Schumann Kinder3	Kinderszennen op.15 "FURCHTENMACHEN"
Schumann Kinder4	Kinderszennen op.15 "VON FREMDEN LANDERN UND MENSCHEN"
Schumann Kinder5	Kinderszennen op.15 "GLUCKES GENUG"
Schumann Kinder6	Kinderszennen op.15 "FAST ZU ERNST"
Schumann Kinder7	Kinderszennen op.15 "KIND IM EINSCHLUMMERN"
Tchaikovsky 1	Barcarolle, op.37a-6
Tchaikovsky 2	Casse-Noisette, op.71A No.2-iv "DANCE ARABE"
Tchaikovsky 3	Morceaux de Fantasie in E flat Minor, op.3 No.1 "ELEGIE"

SOUND DEMO SONG LIST

Piano 1	Concert Grand	Valse, op.64-1 / Chopin
	Studio Grand	Original
	Mellow Grand	La Fille aux Cheveux de Lin / Debussy
	Modern Piano	Original
	Rock Piano	Original *
Piano 2	Concert Grand 2	Original
	New Age Piano 2	Original
Electric Piano	Classic E.Piano	Original
	Modern E.P.	Original
	Modern E.P. 2	Original
Drawbars	Jazz Organ	Original
	Drawbar Organ 1	Original
	Drawbar Organ 2	Original
Church Organ	Church Organ	Toccata / Eugene Gigout
	Diapason	Wohl mir, daß ich Jesum habe / Bach
	Full Ensemble	Original
Harpsi&Mallets	Harpsichord	French Suite No. 6 / Bach
	Vibraphone	Original
	Clavi	Original
	Harpsichord Oct.	Prelude in A ^b / Bach *
Strings	Slow Strings	Original
	String Pad	Original
	String Ensemble	Le quattro stagioni La primavera / Vivaldi
Vocal	Choir	Original
	Jazz Ensemble	Original
Pad	New Age Pad	Original
	Atmosphere	Original
Bass&Guitar	Wood Bass	Original
	Electric Bass	Original
	W. Bass & Ride	Original
	Ballad Guitar	Original
	Pick Nylon Gt.	Original

* CA9 only

Front Panel

VOLUME SLIDER (p. 10) DEMO (p. 11), REGISTRATION (p. 15), PIANO MUSIC (p. 11)

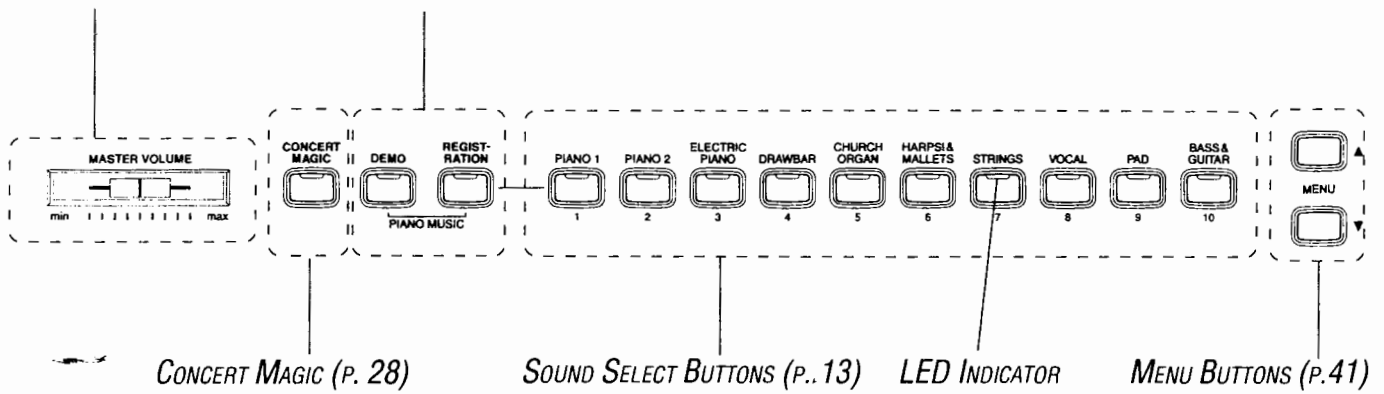

LCD DISPLAY EFFECT BUTTONS (P. 16) SPLIT BUTTON (P. 14) RECORDER BUTTONS (P. 22) TRANSPOSE BUTTON (P. 18)

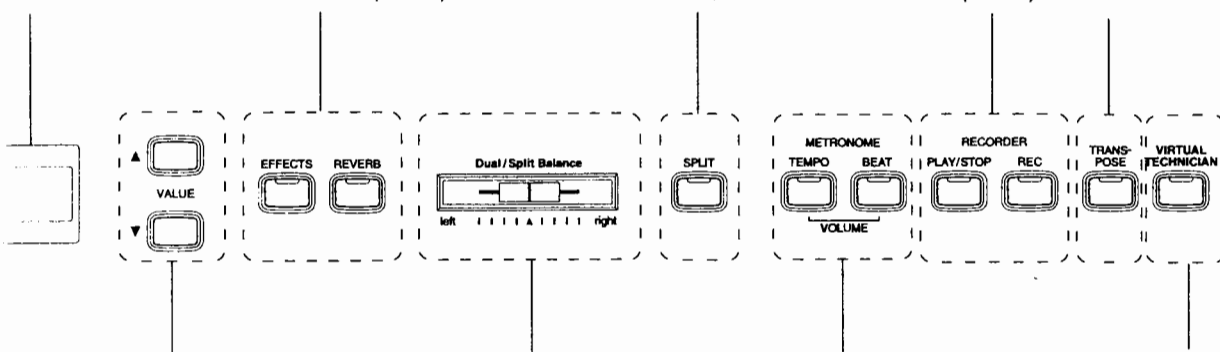

VALUE BUTTONS (P. 14) DUAL/SPLIT BALANCE SLIDER (P. 15) METRONOME BUTTONS (P. 19) VIRTUAL TECHNICIAN BUTTON (P. 34)

Specifications

	CA9	CA7
Keyboard	88 Wooden Keyboard	
Polyphony	Maximum 96	
Number of Sound	80	60
Sound Categories	Piano 1, Piano 2, Electric Piano, Drawbar, Church Organ, Harpsi & Mallets, Strings, Vocal, Pad, Bass & Guitar	
Effects	Reverb (3), 3-D Reverb (2), Chorus, Tremolo, Delay (3), Rotary (2)	
Temperaments	Equal (Piano Only), Mersenne pure (Major), Mersenne pure (minor), Pythagorea, Meantone, Werckmeister III, Kirnberger III, Equal (flat), Equal, User	
Recorder	2 Tracks, 5 Songs The total memory capacity of the recorder is approximately 15,000 notes.	
Other Features	Concert Magic (176 Preset Songs), Volume, Dual, Split, Dual/Split Balance, Transpose, Tune, Damper Effect, String Resonance, Virtual Voicing, Brilliance, Layer Dynamics, Rhythm Metronome, Lower Octave Shift, Layer Octave Shift, Touch Curve (Light, Light+, Normal, Heavy, Heavy+, Off, User 1/2), MIDI (16 part multi-timbral capability)	
Pedals	Sustain with Half Pedal function, Sostenuto, Soft	
Jacks	Headphone (2), LINE IN (L, R), LINE OUT (L/MONO, R), MIDI (IN, OUT, THRU), USB	
Output Power	60W x 2, 10W x 2	60W x 2
Speakers	13 cm x 2 (with wooden enclosure) 1.9 cm x 2 (dome tweeter) (5 x 9) cm x 2	13 cm x 2 (with enclosure) 1.9 cm x 2 (dome tweeter)
Power Consumption	70W	60 W
Finish	Rosewood, Mahogany, European Cherry	
Dimensions (WxDxH)	1403 x 511 x 937 mm	1388 x 511 x 937 mm
(Not including Music Rack)	56" x 21" x 37"	55" x 21" x 37"
Weight (without bench)	87 kg, 192 LB's	68 kg, 150 LB's

MIDI EXCLUSIVE DATA FORMAT

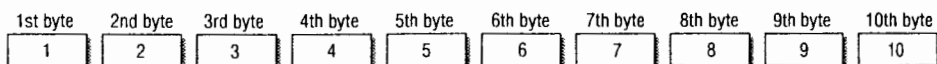

- 1 F0..... Start code
- 2 40..... Kawai's ID number
- 3 00 - 0F MIDI channel
- 4 10, 30..... Function code (30 when setting MULTI TIMBRE ON/OFF)
- 5 04..... Indicates that the instrument is Electronic Piano
- 6 02..... Indicates that the piano is one of "CA" series
- 7 data 1
- 8 data 2..... (See the table below.)
- 9 data 3
- 10 F7..... End code

data 1	data 2	data 3	Function
00	00	—	Multi Timbre Off
00	01	—	Multi Timbre On 1
00	02	—	Multi Timbre On 2
0D	00-07	—	00: Effect Off, 01: Chorus, 02: Delay 1, 03: Delay 2, 04: Delay 3, 05: Tremolo, 06: Rotary 1, 07: Rotary 2
0E	00-03, 06, 07	—	00: Reverb Off, 01: Room 2, 02: Stage, 03: Hall 1, 06: Room 1, 07: Hall 2
14	00-7F	—	Dual/Split balance
16	1F-60	—	Tune, 40: 440 Hz
17	00, 7F	—	00: Program Change Off, 7F: Program Change On
18	00-07	—	00: Light, 01: Normal, 02: Heavy, 03: Off, 04: Light +, 05: Heavy +, 06: User 1, 07: User 2
19	00-03	—	Lower Octave Shift
20	00-4F(3C)	00-4F(3C)	Dual, data 2: Right sound, data 3: Left sound, () for CA7
21	00-4F(3C)	00-4F(3C)	Split, data 2: Upper sound, data 3: Lower sound, () for CA7
25	00-08	00-0B	data 2: Temperament, data 3: Key
26	00, 7F	00-0F	Multi Timbre, data 2: 00 (On), 7F (Off), data 3: channel

MIDI IMPLEMENTATION CHART

KAWAI DIGITAL PIANO MODEL: CA9, CA7

DATE: JANUARY 2004
VERSION 1.0

Function		Transmit	Receive	Remarks
Basic	Default	1	1	
Channel	Changes	1 – 16	1 – 16	
Mode	Default	3	3	* The default for the OMNI mode is ON. Specifying MIDI channels automatically turns it OFF.
	Messages	X	1, 3*	
	Altered	*****		
Note		9 – 120**	0–127	
Number	True voice	*****	15 – 113	
Velocity	Note ON	○ 9nH v=1–127	,○	
	Note OFF	X 9nH v=0	X	
After	Key's	X	X	
Touch	Ch's	X	X	
Pitch Bend		X	X	
	0, 32	○	○	Bank Select
	7	X	○	Volume
	11	X	○	Expression pedal
	64	○ (Right pedal)	○	Sustain pedal
Control	66	○ (Center pedal)	○	Sostenuto pedal
Change	67	○ (Left pedal)	○	Soft pedal
Program		○ 0 – 127	○***	*** See the Program Change Number Mapping in page 78 and 79.
Change	:True #	*****		
System Exclusive		○	○	On/Off Selectable
	: Song Position	X	X	
Common	: Song Select	X	X	
	: Tune	X	X	
System	: Clock	X	X	
Real Time	: Commands	X	X	
Aux	: Local On/Off	X	○	
	: All Notes Off	X	○ (123-127)	
	: Active Sense	○	○	
	: Reset	X	X	
Notes		** The value depends on the Transpose setting.		

Mode 1: OMNI ON, POLY
Mode 3: OMNI OFF, POLY

Mode 2: OMNI ON, MONO
Mode 4: OMNI OFF, MONO

○: Yes
X: No

KAWAI

CA9, CA7 Owner's Manual
OW972E-1.0401
Printed in Japan

英文